

Safety starts with Stell

Catalogue 2024

Plant Labelling

Safety Identification



stell

Safety starts with Stell

Labelling Solutions. Made by Stell



Dear Business Partner,

we are pleased that you are interested in our company and products. For more than 40 years, we have aimed to ensure that working environments are clear-cut and safe. With our high-quality materials and distinct industry knowledge in the fields of energy, chemicals, maritime, industry and fire protection, we are ready to serve as your qualified partner.

The new catalogue offers a comprehensive product selection when it comes to plant labelling and safety identification. With this catalogue, we are providing you with a resource to help you get to know all our products while also facilitating your selection of the product that is most suitable for you.

We are also happy to develop customised solutions for your specific requirements. Our team of experts will help you with any questions you may have.

We look forward to working with you.

Sincerely,

Jan Bernd Stell, Managing Director of Stell GmbH

Contents



STELL GmbH

About the company	4
Our business approach – Labelling in a complete package	5



Plant Labelling

Introduction	8
Original Stell “Stecksystem”	10
Printed and Engraved Signs	32
Slide-In System	36
Pipe Labelling – Stickers and Tapes	54
Tank Labelling	61
Pre-labelling	64
Fastening and Accessories	65
Plans for Process Engineering	72



Safety Identification

Introduction	76
Safety Way Guidance System	78
Safety Signs	82
Safety Markings for Obstacles and Hazardous Areas	95
Floor Marking and Anti-Slip Tapes	96
Knuffi® Warning and Protection Profiles	99
Plans for Safety Identification	102
Fastening and Accessories	105



About the company



Since 1976, we at Stell GmbH have established ourselves as a modern group of medium-sized companies on the market for labelling and signage solutions. Providing comprehension, safety and orientation in buildings, process plants and at sea is our primary goal. High-quality materials and distinct industry knowledge in the fields of energy, chemicals, maritime, industry and fire protection ensure that the working environment is clear-cut and safe for personnel and employees.

The labelling of plants as well as safety identification are among our core competencies. As a global group of companies with branches in Germany, the Netherlands and India, we work together with our partners and customers to ensure comprehensive, effective and correct labelling solutions.

Our aim is to offer you a 100% carefree package. Our business approach allows us to offer you a one-stop-shop for all steps of the process chain. Project planning, production, on-site installation and documentation supervised by qualified consulting – our labelling solutions represent a complete package. Thanks to this approach we provide optimal coverage for all customer requirements. In addition, we have built up a close-knit network of competent and reliable partners and suppliers to provide extra services whenever needed.

The Stell group at a glance

Enduring and reliable

- Over 45 years of experience
- Owner-operated Group of family businesses
- Numerous framework agreements with large corporations
- Sector-specific project references

Competent and customer-oriented

- 110 employees worldwide (DE, NL, IND)
- 90% added value in our own company
- 3,500 m² production and storage space with 7,500 stocked products
- Internationally networked and globally active

Certified and committed

- DIN membership in NASG / NSMT
- Chair of the ISO TC 145 / SC 2
- Safety certificates SCCP / VCA
- Quality certificates ISO 9001 / Wheelmark D
- IMO-certified products / Wheelmark B

Our business approach – Labelling in a complete package

We take a systematic approach – from the consulting phase through to project completion. Our company independently covers each and every step that’s involved and is therefore able to respond your specific project planning. The range of products and services we offer is seamlessly linked and simplifies project implementation in the process.



**Step 1:
PROJECT PLANNING**

Our employees conduct on-site visits to record and examine all the specific requirements involved, thus laying the groundwork for proper project implementation. This procedure allows the material design, relevant quantities, signage text and installation locations to be precisely defined and, if desired, coordinated with you. In the event of missing P&IDs or plans, we’ll check and draw new documents for you so that your project can get off to an effective start.



**Step 2:
PRODUCTION**

The signs and plans are produced according to high quality standards in Bocholt, Germany. This process is flexibly adjusted to the project plan and can be revised if necessary. We also have a well-stocked warehouse with standardised signs and fastening materials that are on hand to ensure smooth project processing.



**Step 3:
INSTALLATION**

Fifty permanently employed, SCC-certified fitters with sound background knowledge and independent working methods come on site to install the signs exactly where they need to be. In performing this task, they refer to the relevant P&IDs and plans. Our team leaders regularly confers with you on the project’s progress and documents it along the way. If desired, this documentation can be done in digital format.

Our products are systematically installed



Plant labelling

Process plant labelling must be systematic.

Our signs and the appropriate fastening materials allow you to employ a uniform approach to labelling components, pipes and containers. Systematically aligned with each other, recognisability, consistency and resistance to environmental influences go hand in hand.

Safety signs

Labelling must provide recognition value.

We offer reliable health and safety signing in accordance with current standards and laws. Various sizes and fastening options are available from stock as standard. In addition, we produce the signs you require using internationally standardised symbols as well as instructions or texts that are tailored to your needs.

Plans and signs for the fire brigade

Preventive fire protection is a matter of trust.

We know the current standards, but we always adapt your plans to the needs of the emergency services on site. Fire brigade plans and route maps are prepared by us – professional on-site survey included. In collaborating with our customers, we use the latest drawing software for our work and thus ensure clear instructions where they are needed.

Industrial signs

Made in Germany! Durable products require steadfast quality.

Our robust signs can withstand harsh environments and display the desired information in the long term. Whether it's for your scales, identification plates, labels or machine plates, we'll find the right material and an approach that's properly adapted to your production site.

Smart signs and the STELL Inspections App

Signs can be SMART too.

Mobile applications offer greater process reliability and efficiency for inspections and maintenance work. With the "Stell Inspections" app, your mobile device becomes the ideal companion for the maintenance process. Our Auto-ID-capable signs provide the ideal starting point to clearly identify your equipment and link it to the modern app system.

Plant Labelling



Introduction	8
---------------------	----------

Original Stell “Stecksystem”	10
Symbol count and distance of observation	12
45 Series	14
06 Series	18
09 Series	22
18 Series	26

Printed and Engraved Signs	32
InSTELLigent Products – Signs with Barcode, Data Matrix and RFID	34

Slide-In System	36
06/09 Series	40
18 Series	43
27 Series	47
36 Series	51

Pipe Labelling – Stickers and Tapes	54
Pipe markers	55
Colour tapes	56
Arrow tapes	57
Text tapes	58
GHS tapes / Hazardous Substance Tapes	59
Module system and adhesive film stickers	60

Tank Labelling	61
-----------------------	-----------

Pre-labelling	64
----------------------	-----------

Fastening and Accessories	65
----------------------------------	-----------

Plans for Process Engineering	72
--------------------------------------	-----------

Introduction



To achieve clear understanding and sustainable work in energy and chemical plants, a distinct knowledge of plant components, pipes, tanks, containers is necessary. These days, straightforward plant labelling is indispensable.

In order to create a safe and comprehensive work environment it needs suitable planning, correct choice of the required labelling and professional fastening of the signs – which Stell offers as a complete package. During the planning phase we evaluate the on-site situation and the existing documentation. Should the required documentation, e.g. sign lists or up-to-date P&IDs, not be available we'll be happy to compile these for you, already taking into consideration the best choice of products and fastening materials. During the next phase, our expert staff independently carries out the labelling in a safe and professional manner for you. All of these tasks are included in the labelling project documentation (also in digital form of your choice) that will be handed out to you upon completion of the project or agreed parts of the project.

Thanks to a sophisticated product range, we are able to aid in providing comprehension and efficiency at your location. Whether specific identification Systems for Power Stations (KKS), plant labelling systems or customer coding, our signs permanently and concisely display essential information, facilitate communication and serve as a visual aid for you and your employees in your daily work. In addition, proper plant labelling helps to prevent operator errors or accidents and reduces the operating, maintenance and servicing costs throughout the entire service life.

Graphic 1 Group and additional colour of the fluid content (DIN 2403)

Application	Oxygen	Water	Steam	Air	Flammable gases	Non flammable gases	Acids	Alkalis	Flammable liquids and fixed materials	Non flammable liquids and fixed materials
<i>Group colour</i>	RAL5005	RAL6032	RAL3001	RAL7004	RAL1003	RAL1003	RAL2010	RAL4008	RAL8002	RAL8002
<i>Additional colour</i>	–	–	–	–	RAL3001	RAL9004	–	–	RAL3001	RAL9004
<i>Text colour</i>	RAL9003*	RAL9003*	RAL9003*	RAL9004	RAL9004	RAL9004	RAL9004	RAL9003*	RAL9003*	RAL9003*

* white

Graphic 2

CLP/GHS Pictogram Symbols and Hazard Classes

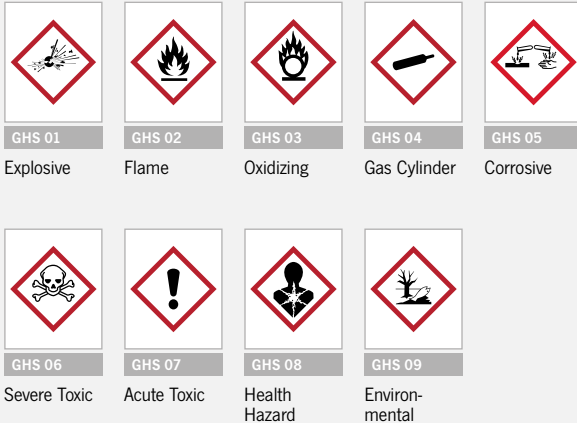

Compulsory labelling and its implementation – standards and laws

Plant labelling is either regulated by international law in its various areas of application, or existing standards apply as directives. In Europe, safety-relevant labels are required by law – especially at the workplace. In addition to the above mentioned identification Systems for Power Stations (KKS) or its successors – the Reference Designation System for Power Plants and plant labelling system – there are further regulations, standards and laws which are crucial to plant labelling.

Generally, plant labelling requires the labelling to be concise and in accordance with the latest technological standards.

Our labelling is designed according to German standard DIN 2403 (see [graphic 1](#)) as well as Germany’s Gefahrstoffverordnung (GefStoffV, see [graphic 2](#)), or “Ordinance on Hazardous Substances”, and can be adapted to your individual needs. We would be pleased to advise you on your labelling obligations, functional set-ups and our in-house labelling systems.

How to label according to German DIN standards

With DIN 2403, the German Institute for Standardization defines the currently valid technology standard for labelling pipes according to their content for above ground pipes on land. In DIN 2403, the following components are defined as compulsory minimum specifications:

- Group and additional colour of the content
- Flow direction
- Indication of the fluid content

Other indicators (pressure, temperature, etc.) are optional.

Furthermore, the standard specifies how large a label should be depending on its distance of observation, and it makes several labelling recommendations that should be followed.

Graphic 3 Example distance of observation (scale 1:1)

A Distance of observation (D) text = 1,5 m



B Distance of observation (D) GHS symbol = 1,5 m

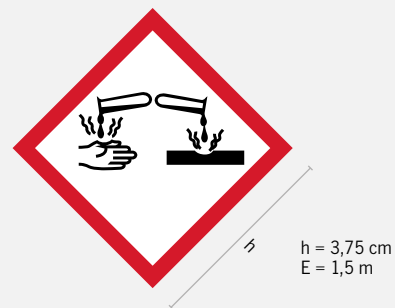

Specify the correct distance of observation

A formula is used for calculating and deciding on a label’s size (see [graphic 3](#)) and the font height.

$$D = h \times Z$$

Whereby:

- D = the distance of observation,
- h = the font height, resp. symbol height
- Z = the distance factor.
300 for letters and numbers
40 for hazard symbols

For us, the distance of observation is determined on two levels. Either the correct font height can be calculated from the desired distance of observation on site, or, depending on the maximum distance of observation, the correct installation location for the labelling can be determined from the potential font height at the site.

Original Stell "Stecksystem"



The original Stell "Stecksystem" is a patented product for plant labelling that is specially designed for the labelling of components. Consisting of a sign-bracket, a slide-in profile, individually insertable symbols (letters, numbers etc.) and outer elements, the "Stecksystem" allows you to individually handle and design your sign. All symbols can be exchanged and contents can be adjusted when required.

Codings and information are flexibly compiled as individual symbols and can be supplemented with hazardous substance or GHS pictograms, the medium's desired flow direction and its group colour in accordance with DIN 2403. The "Stecksystem" is available in various series which can be ideally combined, regardless of size.

Two material designs are available for all series. Our trademark Luxotherm® plastic offers tremendous resistance against UV radiation and contains zero chlorides. All symbols and slide-in profiles are also available as aluminium versions should temperatures in the application area be higher. On request, the original Stell "Stecksystem" can be delivered with the necessary fastening material.



18 series

Slide-in profile = 126 mm, half outer elements

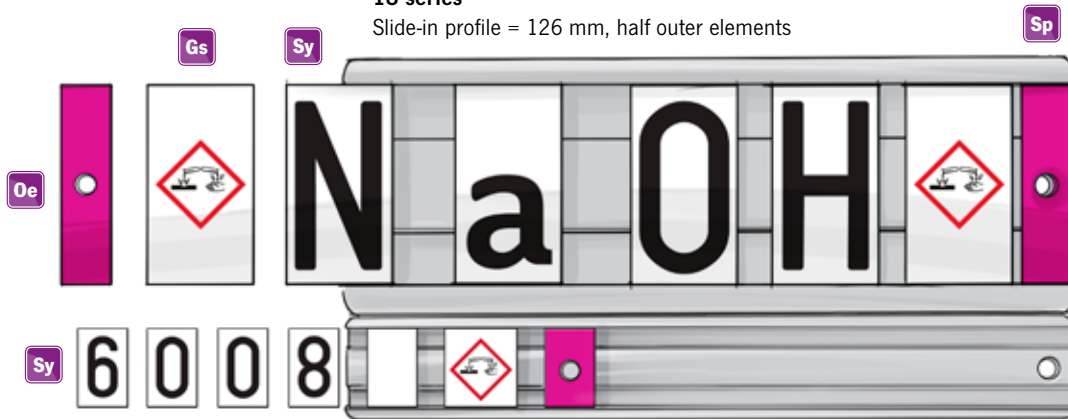

06/09 series

Slide-in profile = 126 mm, full outer elements

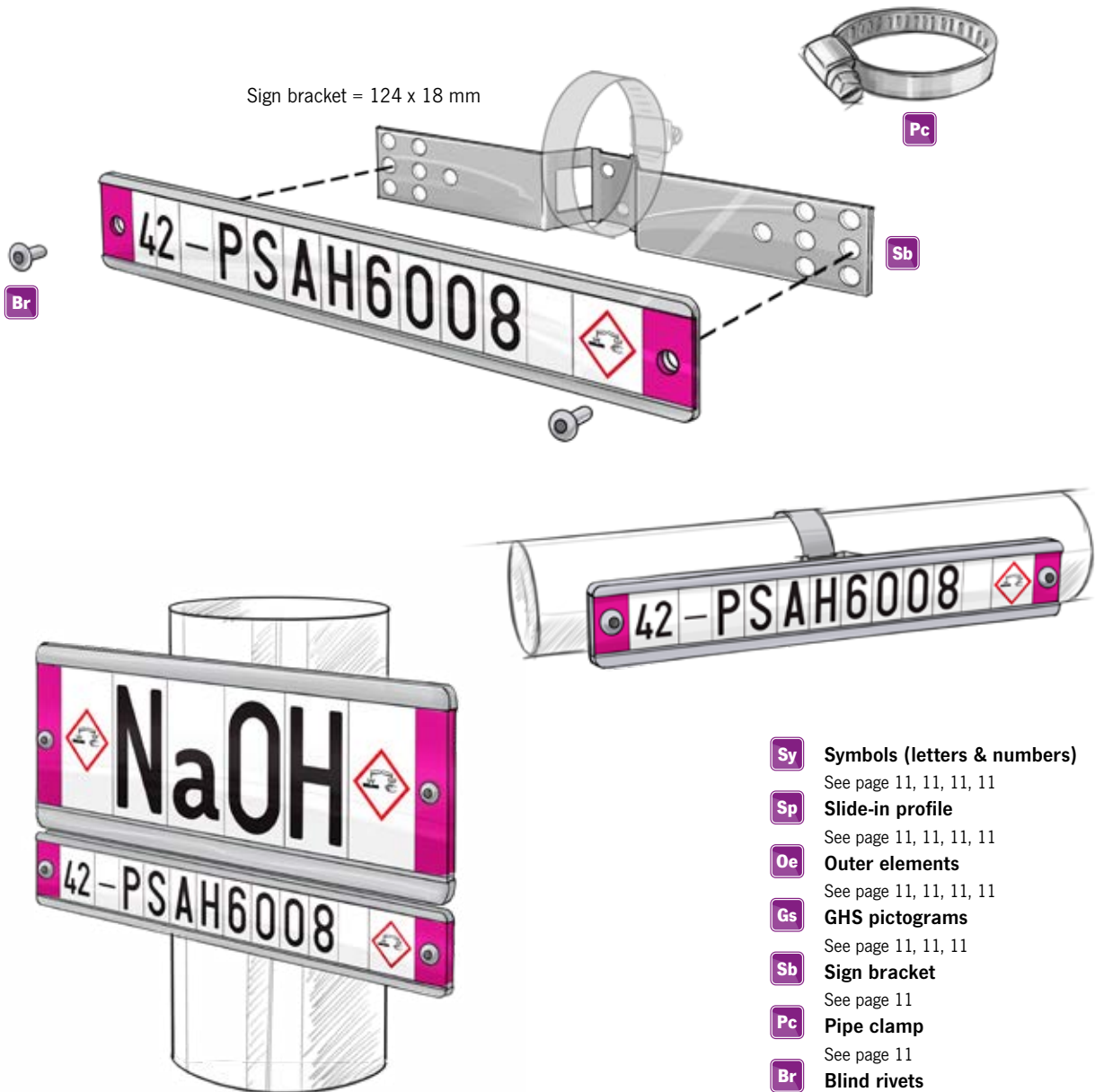

Sign bracket = 124 x 18 mm

- Sy** Symbols (letters & numbers)
See page 11, 11, 11, 11
- Sp** Slide-in profile
See page 11, 11, 11, 11
- Oe** Outer elements
See page 11, 11, 11, 11
- Gs** GHS pictograms
See page 11, 11, 11
- Sb** Sign bracket
See page 11
- Pc** Pipe clamp
See page 11
- Br** Blind rivets
See page 11





Symbol count and distance of observation

As the height of the font determines the distance of observation of your sign we offer the "Stecksystem" in different series, providing good visibility at close and long range. Having determined the required distance of observation and the corresponding font height you will now have to choose the number of symbols.

The overview shows how many characters and symbols will fit in a slide-in profile of a given length. Additionally, on the right side you can find a few examples of possible combinations of these series and the integration of special symbols as e.g. the GHS pictograms.

Possible combinations of the "Stecksystem" series

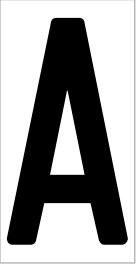
	45 series	06 series	09 series	18 series
				
Font height	5 mm	8 mm	10 mm	30 mm
Observation distance	1,5 m	2,4 m	3 m	9 m

Slide-in profile	Symbol count (with full outer elements)			
45 mm	6	-	-	-
54 mm	8	-	-	-
63 mm	10	-	-	-
72 mm	12	9	6	2 / 3*
81 mm	14	-	-	-
90 mm	16	12	8	3 / 4*
99 mm	18	-	-	-
108 mm	20	15	10	4 / 5*
126 mm	24	18	12	5 / 6*
144 mm	28	21	14	6 / 7*
162 mm	32	24	16	7 / 8*
180 mm	36	27	18	8 / 9*
198 mm	-	30	20	9 / 10*
216 mm	-	33	22	10 / 11*
234 mm	-	36	24	11 / 12*
252 mm	-	39	26	12 / 13*
270 mm	-	42	28	13 / 14*
288 mm	-	45	30	14 / 15*
306 mm	-	48	32	15 / 16*
324 mm	-	51	34	16 / 17*
342 mm	-	-	-	17 / 18*
360 mm	-	-	-	18 / 19*

- = length not available

*half outer elements

 = example on page 13

Examples in original size

45 Series



06 Series

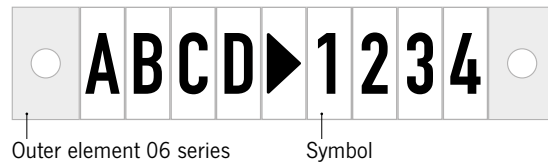

09 Series

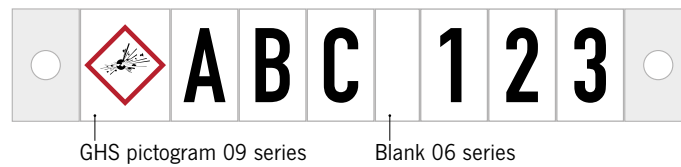
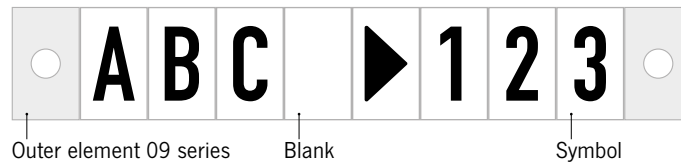

18 Series

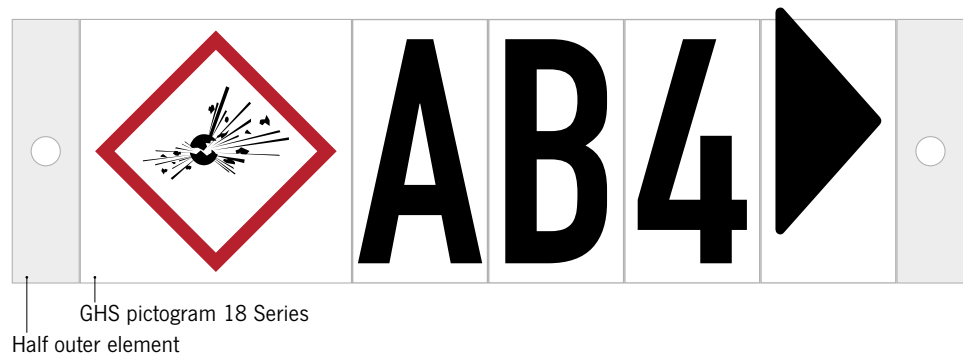
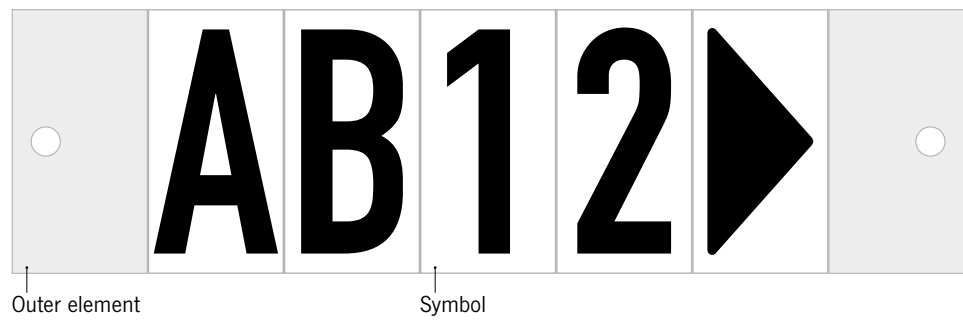

45 Series

Distance of observation 1,5 m

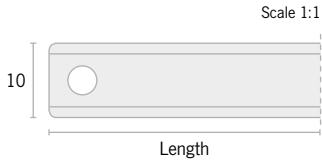

Sp Slide-in profiles

Material		Quantity	Article		
Chlorid free plastic P / Aluminium, anodised A		5 pieces	0002		
Length	Number of symbols*	Order-No.	Price	Order-No.	Price
45 mm	6	P 2061	€ 1,70	A 2049	€ 2,55
54 mm	8	P 2062	€ 1,85	A 2050	€ 2,70
63 mm	10	P 2063	€ 2,00	A 2051	€ 2,85
72 mm	12	P 2064	€ 2,15	A 2052	€ 3,00
81 mm	14	P 2065	€ 2,30	A 2053	€ 3,15
90 mm	16	P 2066	€ 2,45	A 2054	€ 3,30
99 mm	18	P 2067	€ 2,60	A 2055	€ 3,45
108 mm	20	P 2068	€ 2,75	A 2056	€ 3,60
126 mm	24	P 2069	€ 3,05	A 2057	€ 3,90
144 mm	28	P 2070	€ 3,35	A 2058	€ 4,20
162 mm	32	P 2071	€ 3,65	A 2059	€ 4,50

*The number of symbols takes into account that 2 outer elements are always added.

Fastening

Find the suitable fastening from our system starting on page 65

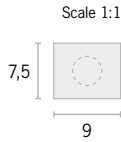

Oe Outer elements

Material	Quantity	Article
Luxotherm® L / Aluminium, anodised A	15 pieces	0001

DIN 2403		No colour	Oxygen	Water	Steam	Air
Design	Mat.	Neutral	RAL5005	RAL6032	RAL3001	RAL7004
		Group 0	Group 1	Group 2	Group 3	
without hole	Order-No. L	2338	2322	2324	2326	2328
	Price	€ 1,15	€ 1,15	€ 1,15	€ 1,15	€ 1,15
with hole	Order-No. A	2318	2302	2304	2306	2308
	Price	€ 2,10	€ 2,10	€ 2,10	€ 2,10	€ 2,10
without hole	Order-No. L	2337	2321	2323	2325	2327
	Price	€ 1,15	€ 1,15	€ 1,15	€ 1,15	€ 1,15
with hole	Order-No. A	2317	2301	2303	2305	2307
	Price	€ 2,10	€ 2,10	€ 2,10	€ 2,10	€ 2,10

		Gases	Acids	Alkalis	Liquids and fixed materials	Additional colour
Design	Mat.	RAL1003	RAL2010	RAL4008	RAL8002	Black
		Group 4/5	Group 6	Group 7	Group 8/9	Zusatz
without hole	Order-No. L	2330	2332	2334	2336	2340
	Price	€ 1,15	€ 1,15	€ 1,15	€ 1,15	€ 1,15
with hole	Order-No. A	2310	2312	2314	2316	2320
	Price	€ 2,10	€ 2,10	€ 2,10	€ 2,10	€ 2,10
without hole	Order-No. L	2329	2331	2333	2335	2339
	Price	€ 1,15	€ 1,15	€ 1,15	€ 1,15	€ 1,15
with hole	Order-No. A	2309	2311	2313	2315	2319
	Price	€ 2,10	€ 2,10	€ 2,10	€ 2,10	€ 2,10

NEN 3050		No colour	Steam	Fire fighting	Gases and liquid gases	Alkalis
Design	Mat.		RAL9006	RAL3000	RAL1004	RAL4001
without hole	Order-No. L	2338	2372	2362	2364	2360
	Price	€ 1,15	€ 1,15	€ 1,15	€ 1,15	€ 1,15
with hole	Order-No. A	2318	2354	2344	2346	2342
	Price	€ 2,10	€ 2,10	€ 2,10	€ 2,10	€ 2,10
without hole	Order-No. L	2337	2371	2361	2363	2359
	Price	€ 1,15	€ 1,15	€ 1,15	€ 1,15	€ 1,15
with hole	Order-No. A	2317	2353	2343	2345	2341
	Price	€ 2,10	€ 2,10	€ 2,10	€ 2,10	€ 2,10

		Air	Oils and flammable liquids	Acids	Acids	Other liquids
Design	Mat.	RAL5012	RAL8001	RAL2008	RAL6010	Black
without hole	Order-No. L	2366	2368	2376	2374	2340
	Price	€ 1,15	€ 1,15	€ 1,15	€ 1,15	€ 1,15
with hole	Order-No. A	2348	2350	2358	2356	2320
	Price	€ 2,10	€ 2,10	€ 2,10	€ 2,10	€ 2,10
without hole	Order-No. L	2365	2367	2375	2373	2339
	Price	€ 1,15	€ 1,15	€ 1,15	€ 1,15	€ 1,15
with hole	Order-No. A	2347	2349	2357	2355	2319
	Price	€ 2,10	€ 2,10	€ 2,10	€ 2,10	€ 2,10

45 Series

Distance of observation 1,5 m

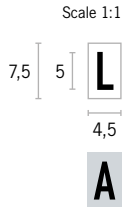

Sy Symbols

		Material (colours)								Quantity	Article
		Luxotherm® L (white/black) / Aluminium, anodised A silver/black								25 pieces	0003
		<div style="display: flex; justify-content: space-around; font-size: 2em; font-weight: bold;"> AaBbCcDdEe </div>									
		<i>Mat.</i>									
Order-No.	L	1906	1939	1908	1941	1909	1942	1910	1943	1911	1944
Price		€ 1,05	€ 1,05	€ 1,05	€ 1,05	€ 1,05	€ 1,05	€ 1,05	€ 1,05	€ 1,05	€ 1,05
Order-No.	A	1816	1849	1818	1851	1819	1852	1820	1853	1821	1854
Price		€ 1,90	€ 1,90	€ 1,90	€ 1,90	€ 1,90	€ 1,90	€ 1,90	€ 1,90	€ 1,90	€ 1,90
		<div style="display: flex; justify-content: space-around; font-size: 2em; font-weight: bold;"> FfGgHhIiJj </div>									
		<i>Mat.</i>									
Order-No.	L	1912	1945	1913	1946	1914	1947	1915	1948	1916	1949
Price		€ 1,05	€ 1,05	€ 1,05	€ 1,05	€ 1,05	€ 1,05	€ 1,05	€ 1,05	€ 1,05	€ 1,05
Order-No.	A	1822	1855	1823	1856	1824	1857	1825	1858	1826	1859
Price		€ 1,90	€ 1,90	€ 1,90	€ 1,90	€ 1,90	€ 1,90	€ 1,90	€ 1,90	€ 1,90	€ 1,90
		<div style="display: flex; justify-content: space-around; font-size: 2em; font-weight: bold;"> KkLlMmNnOo </div>									
		<i>Mat.</i>									
Order-No.	L	1917	1950	1918	1951	1919	1952	1920	1953	1921	1954
Price		€ 1,05	€ 1,05	€ 1,05	€ 1,05	€ 1,05	€ 1,05	€ 1,05	€ 1,05	€ 1,05	€ 1,05
Order-No.	A	1827	1860	1828	1861	1829	1862	1830	1863	1831	1864
Price		€ 1,90	€ 1,90	€ 1,90	€ 1,90	€ 1,90	€ 1,90	€ 1,90	€ 1,90	€ 1,90	€ 1,90
		<div style="display: flex; justify-content: space-around; font-size: 2em; font-weight: bold;"> PpQqRrSsTt </div>									
		<i>Mat.</i>									
Order-No.	L	1923	1956	1924	1957	1925	1958	1926	1959	1927	1960
Price		€ 1,05	€ 1,05	€ 1,05	€ 1,05	€ 1,05	€ 1,05	€ 1,05	€ 1,05	€ 1,05	€ 1,05
Order-No.	A	1833	1866	1834	1867	1835	1868	1836	1869	1837	1870
Price		€ 1,90	€ 1,90	€ 1,90	€ 1,90	€ 1,90	€ 1,90	€ 1,90	€ 1,90	€ 1,90	€ 1,90
		<div style="display: flex; justify-content: space-around; font-size: 2em; font-weight: bold;"> UuVvWwXxYy </div>									
		<i>Mat.</i>									
Order-No.	L	1928	1961	1930	1963	1931	1964	1932	1965	1933	1966
Price		€ 1,05	€ 1,05	€ 1,05	€ 1,05	€ 1,05	€ 1,05	€ 1,05	€ 1,05	€ 1,05	€ 1,05
Order-No.	A	1838	1871	1840	1873	1841	1874	1842	1875	1843	1876
Price		€ 1,90	€ 1,90	€ 1,90	€ 1,90	€ 1,90	€ 1,90	€ 1,90	€ 1,90	€ 1,90	€ 1,90

		Z	z	0	1	2	3	4	5	6	7
	Mat.										
Order-No.	L	1934	1967	1982	1983	1984	1985	1986	1987	1988	1989
Price		€ 1,05	€ 1,05	€ 1,05	€ 1,05	€ 1,05	€ 1,05	€ 1,05	€ 1,05	€ 1,05	€ 1,05
Order-No.	A	1844	1877	1892	1893	1894	1895	1896	1897	1898	1899
Price		€ 1,90	€ 1,90	€ 1,90	€ 1,90	€ 1,90	€ 1,90	€ 1,90	€ 1,90	€ 1,90	€ 1,90

		8	9	2	2	3	3	4	4	!	:
	Mat.										
Order-No.	L	1990	1991	1935	1979	1936	1980	1937	1981	1903	1904
Price		€ 1,05	€ 1,05	€ 1,05	€ 1,05	€ 1,05	€ 1,05	€ 1,05	€ 1,05	€ 1,05	€ 1,05
Order-No.	A	1900	1901	1845	1889	1846	1890	1847	1891	1813	1814
Price		€ 1,90	€ 1,90	€ 1,90	€ 1,90	€ 1,90	€ 1,90	€ 1,90	€ 1,90	€ 1,90	€ 1,90

		=	+	()	,	.	-	▶	▲	±
	Mat.										
Order-No.	L	1905	1975	1938	1968	1969	1977	1971	1972	1973	1974
Price		€ 1,05	€ 1,05	€ 1,05	€ 1,05	€ 1,05	€ 1,05	€ 1,05	€ 1,05	€ 1,05	€ 1,05
Order-No.	A	1815	1885	1848	1878	1879	1887	1881	1882	1883	1884
Price		€ 1,90	€ 1,90	€ 1,90	€ 1,90	€ 1,90	€ 1,90	€ 1,90	€ 1,90	€ 1,90	€ 1,90

		%	/	"	
	Mat.				
Order-No.	L	1976	1978	1992	1970
Price		€ 1,05	€ 1,05	€ 1,05	€ 1,05
Order-No.	A	1886	1888	1902	1880
Price		€ 1,90	€ 1,90	€ 1,90	€ 1,90

06 Series

Distance of observation 2,4 m

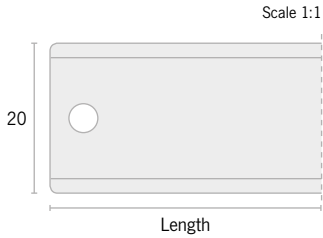







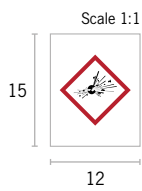

Sp Slide-in profiles

Material		Quantity	Article		
Chlorid free plastic P / Aluminium, anodised A		5 pieces	0002		
Length	Number of symbols*	Order-No.	Price	Order-No.	Price
72 mm	9	P 2008	€ 2,75	A 1993	€ 4,00
90 mm	12	P 2009	€ 3,00	A 1994	€ 4,25
108 mm	15	P 2010	€ 3,25	A 1995	€ 4,50
126 mm	18	P 2011	€ 3,50	A 1996	€ 4,75
144 mm	21	P 2012	€ 3,75	A 1997	€ 5,00
162 mm	24	P 2013	€ 4,00	A 1998	€ 5,25
180 mm	27	P 2014	€ 4,25	A 1999	€ 5,50
198 mm	30	P 2015	€ 4,50	A 2000	€ 5,75
216 mm	33	P 2016	€ 4,75	A 2001	€ 6,00
234 mm	36	P 2017	€ 5,00	A 2002	€ 6,25
252 mm	39	P 2018	€ 5,25	A 2003	€ 6,50
270 mm	42	P 2019	€ 5,50	A 2004	€ 6,75
288 mm	45	P 2020	€ 6,00	A 2005	€ 7,25
306 mm	48	P 2021	€ 6,50	A 2006	€ 7,85
324 mm	51	P 2022	€ 7,00	A 2007	€ 8,35

*The number of symbols takes into account that there are always two additional outer elements.
1 GHS symbol has the same width as 2 symbols.



Gs GHS pictograms

Material		Quantity	Article		
Luxotherm® L / Aluminium, anodised A		10 pieces	0003		
					
<i>Mat.</i>	GHS 01	GHS 02	GHS 03	GHS 04	GHS 05
Order-No.	L 1246	1247	1248	1249	1250
Price	€ 1,65	€ 1,65	€ 1,65	€ 1,65	€ 1,65
Order-No.	A 1237	1238	1239	1240	1241
Price	€ 3,30	€ 3,30	€ 3,30	€ 3,30	€ 3,30
					
<i>Mat.</i>	GHS 06	GHS 07	GHS 08	GHS 09	
Order-No.	L 1251	1252	1253	1254	
Price	€ 1,65	€ 1,65	€ 1,65	€ 1,65	
Order-No.	A 1242	1243	1244	1245	
Price	€ 3,30	€ 3,30	€ 3,30	€ 3,30	

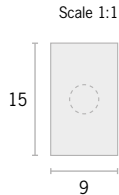

Oe Outer elements

Material	Quantity	Article
Luxotherm® L (yellow/black) L (white/black) / Aluminium, anodised A silver/black	15 pieces	0001

DIN 2403		No colour	Oxygen	Water	Steam	Air
Design	Mat.	Neutral	Group 0	Group 1	Group 2	Group 3
	L	41694 € 1,30	-	-	-	-
without hole	L	2110 € 1,30	2094 € 1,30	2096 € 1,30	2098 € 1,30	2100 € 1,30
	A	2090 € 2,40	2074 € 2,40	2076 € 2,40	2078 € 2,40	2080 € 2,40
	L	41695 € 1,30	-	-	-	-
with hole	L	2109 € 1,30	2093 € 1,30	2095 € 1,30	2097 € 1,30	2099 € 1,30
	A	2089 € 2,40	2073 € 2,40	2075 € 2,40	2077 € 2,40	2079 € 2,40

		Gases	Acids	Alkalis	Liquids and fixed materials	Additional colour
Design	Mat.	Group 4/5	Group 6	Group 7	Group 8/9	Zusatz
	L	2102 € 1,30	2104 € 1,30	2106 € 1,30	2108 € 1,30	2112 € 1,30
without hole	A	2082 € 2,40	2084 € 2,40	2086 € 2,40	2088 € 2,40	2092 € 2,40
	L	2101 € 1,30	2103 € 1,30	2105 € 1,30	2107 € 1,30	2111 € 1,30
with hole	A	2081 € 2,40	2083 € 2,40	2085 € 2,40	2087 € 2,40	2091 € 2,40

NEN 3050		No colour	Steam	Fire fighting	Gases and liquid gases	Alkalis
Design	Mat.	Neutral	RAL9006	RAL3000	RAL1004	RAL4001
	L	41694 € 1,30	-	-	-	-
without hole	L	2110 € 1,30	2144 € 1,30	2134 € 1,30	2136 € 1,30	2132 € 1,30
	A	2090 € 2,40	2126 € 2,40	2116 € 2,40	2118 € 2,40	2114 € 2,40
	L	41695 € 1,30	-	-	-	-
with hole	L	2109 € 1,30	2143 € 1,30	2133 € 1,30	2135 € 1,30	2131 € 1,30
	A	2089 € 2,40	2125 € 2,40	2115 € 2,40	2117 € 2,40	2113 € 2,40

		Air	Oils and flammable liquids	Acids	Acids	Other liquids
Design	Mat.	RAL5012	RAL8001	RAL2008	RAL6010	Schwarz
	L	2138 € 1,30	2140 € 1,30	2148 € 1,30	2146 € 1,30	2112 € 1,30
without hole	A	2120 € 2,40	2122 € 2,40	2130 € 2,40	2128 € 2,40	2092 € 2,40
	L	2137 € 1,30	2139 € 1,30	2147 € 1,30	2145 € 1,30	2111 € 1,30
with hole	A	2119 € 2,40	2121 € 2,40	2129 € 2,40	2127 € 2,40	2091 € 2,40

06 Series

Distance of observation 2,4 m

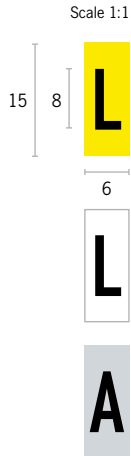

Sy Symbols

		Material (colours)								Quantity	Article
		Luxotherm® L (yellow/black) L (white/black) / Aluminium, anodised A silver/black								20 pieces	0003
		A	a	B	b	C	c	D	d	E	e
Mat.											
Order-No.	L	1062	1128	1066	1132	1068	1134	1070	1136	1072	1138
Price	L	€ 1,10	€ 1,10	€ 1,10	€ 1,10	€ 1,10	€ 1,10	€ 1,10	€ 1,10	€ 1,10	€ 1,10
Order-No.	L	1063	1129	1067	1133	1069	1135	1071	1137	1073	1139
Price	L	€ 1,10	€ 1,10	€ 1,10	€ 1,10	€ 1,10	€ 1,10	€ 1,10	€ 1,10	€ 1,10	€ 1,10
Order-No.	A	969	1002	971	1004	972	1005	973	1006	974	1007
Price	A	€ 2,00	€ 2,00	€ 2,00	€ 2,00	€ 2,00	€ 2,00	€ 2,00	€ 2,00	€ 2,00	€ 2,00
		F	f	G	g	H	h	I	i	J	j
Mat.											
Order-No.	L	1074	1140	1076	1142	1078	1144	1080	1146	1082	1148
Price	L	€ 1,10	€ 1,10	€ 1,10	€ 1,10	€ 1,10	€ 1,10	€ 1,10	€ 1,10	€ 1,10	€ 1,10
Order-No.	L	1075	1141	1077	1143	1079	1145	1081	1147	1083	1149
Price	L	€ 1,10	€ 1,10	€ 1,10	€ 1,10	€ 1,10	€ 1,10	€ 1,10	€ 1,10	€ 1,10	€ 1,10
Order-No.	A	975	1008	976	1009	977	1010	978	1011	979	1012
Price	A	€ 2,00	€ 2,00	€ 2,00	€ 2,00	€ 2,00	€ 2,00	€ 2,00	€ 2,00	€ 2,00	€ 2,00
		K	k	L	l	M	m	N	n	O	o
Mat.											
Order-No.	L	1084	1150	1086	1152	1088	1154	1090	1156	1092	1158
Price	L	€ 1,10	€ 1,10	€ 1,10	€ 1,10	€ 1,10	€ 1,10	€ 1,10	€ 1,10	€ 1,10	€ 1,10
Order-No.	L	1085	1151	1087	1153	1089	1155	1091	1157	1093	1159
Price	L	€ 1,10	€ 1,10	€ 1,10	€ 1,10	€ 1,10	€ 1,10	€ 1,10	€ 1,10	€ 1,10	€ 1,10
Order-No.	A	980	1013	981	1014	982	1015	983	1016	984	1017
Price	A	€ 2,00	€ 2,00	€ 2,00	€ 2,00	€ 2,00	€ 2,00	€ 2,00	€ 2,00	€ 2,00	€ 2,00
		P	p	Q	q	R	r	S	s	T	t
Mat.											
Order-No.	L	1096	1162	1098	1164	1100	1166	1102	1168	1104	1170
Price	L	€ 1,10	€ 1,10	€ 1,10	€ 1,10	€ 1,10	€ 1,10	€ 1,10	€ 1,10	€ 1,10	€ 1,10
Order-No.	L	1097	1163	1099	1165	1101	1167	1103	1169	1105	1171
Price	L	€ 1,10	€ 1,10	€ 1,10	€ 1,10	€ 1,10	€ 1,10	€ 1,10	€ 1,10	€ 1,10	€ 1,10
Order-No.	A	986	1019	987	1020	988	1021	989	1022	990	1023
Price	A	€ 2,00	€ 2,00	€ 2,00	€ 2,00	€ 2,00	€ 2,00	€ 2,00	€ 2,00	€ 2,00	€ 2,00
		U	u	V	v	W	w	X	x	Y	y
Mat.											
Order-No.	L	1106	1172	1110	1176	1112	1178	1114	1180	1116	1182
Price	L	€ 1,10	€ 1,10	€ 1,10	€ 1,10	€ 1,10	€ 1,10	€ 1,10	€ 1,10	€ 1,10	€ 1,10
Order-No.	L	1107	1173	1111	1177	1113	1179	1115	1181	1117	1183
Price	L	€ 1,10	€ 1,10	€ 1,10	€ 1,10	€ 1,10	€ 1,10	€ 1,10	€ 1,10	€ 1,10	€ 1,10
Order-No.	A	991	1024	993	1026	994	1027	995	1028	996	1029
Price	A	€ 2,00	€ 2,00	€ 2,00	€ 2,00	€ 2,00	€ 2,00	€ 2,00	€ 2,00	€ 2,00	€ 2,00

		Z	z	0	1	2	3	4	5	6	7
	Mat.										
Order-No.	L	1118	1184	1214	1216	1218	1220	1222	1224	1226	1228
Price		€ 1,10	€ 1,10	€ 1,10	€ 1,10	€ 1,10	€ 1,10	€ 1,10	€ 1,10	€ 1,10	€ 1,10
Order-No.	L	1119	1185	1215	1217	1219	1221	1223	1225	1227	1229
Price		€ 1,10	€ 1,10	€ 1,10	€ 1,10	€ 1,10	€ 1,10	€ 1,10	€ 1,10	€ 1,10	€ 1,10
Order-No.	A	997	1030	1045	1046	1047	1048	1049	1050	1051	1052
Price		€ 2,00	€ 2,00	€ 2,00	€ 2,00	€ 2,00	€ 2,00	€ 2,00	€ 2,00	€ 2,00	€ 2,00

		8	9	2	2	3	3	4	4	!	:
	Mat.										
Order-No.	L	1230	1232	1120	1208	1122	1210	1124	1212	1056	1058
Price		€ 1,10	€ 1,10	€ 1,10	€ 1,10	€ 1,10	€ 1,10	€ 1,10	€ 1,10	€ 1,10	€ 1,10
Order-No.	L	1231	1233	1121	1209	1123	1211	1125	1213	1057	1059
Price		€ 1,10	€ 1,10	€ 1,10	€ 1,10	€ 1,10	€ 1,10	€ 1,10	€ 1,10	€ 1,10	€ 1,10
Order-No.	A	1053	1054	998	1042	999	1043	1000	1044	966	967
Price		€ 2,00	€ 2,00	€ 2,00	€ 2,00	€ 2,00	€ 2,00	€ 2,00	€ 2,00	€ 2,00	€ 2,00

		=	+	()	,	.	-	▶	▲	±
	Mat.										
Order-No.	L	1060	1200	1126	1186	1188	1204	1192	1194	1196	1198
Price		€ 1,10	€ 1,10	€ 1,10	€ 1,10	€ 1,10	€ 1,10	€ 1,10	€ 1,10	€ 1,10	€ 1,10
Order-No.	L	1061	1201	1127	1187	1189	1205	1193	1195	1197	1199
Price		€ 1,10	€ 1,10	€ 1,10	€ 1,10	€ 1,10	€ 1,10	€ 1,10	€ 1,10	€ 1,10	€ 1,10
Order-No.	A	968	1038	1001	1031	1032	1040	1034	1035	1036	1037
Price		€ 2,00	€ 2,00	€ 2,00	€ 2,00	€ 2,00	€ 2,00	€ 2,00	€ 2,00	€ 2,00	€ 2,00

		%	/	..	
	Mat.				
Order-No.	L	1202	1206	1234	1190
Price		€ 1,10	€ 1,10	€ 1,10	€ 1,10
Order-No.	L	1203	1207	1235	1191
Price		€ 1,10	€ 1,10	€ 1,10	€ 1,10
Order-No.	A	1039	1041	1055	1033
Price		€ 2,00	€ 2,00	€ 2,00	€ 2,00

09 Series

Distance of observation 3 m

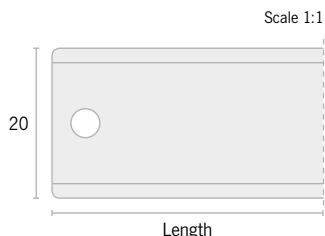

Sp Slide-in profiles

Material		Quantity	Article	
Chlorid free plastic P / Aluminium, anodised A		5 pieces	0002	
Length	Number of symbols*	Mat.	Order-No.	Price
72 mm	6	P	2008	€ 2,75
90 mm	8	P	2009	€ 3,00
108 mm	10	P	2010	€ 3,25
126 mm	12	P	2011	€ 3,50
144 mm	14	P	2012	€ 3,75
162 mm	16	P	2013	€ 4,00
180 mm	18	P	2014	€ 4,25
198 mm	20	P	2015	€ 4,50
216 mm	22	P	2016	€ 4,75
234 mm	24	P	2017	€ 5,00
252 mm	26	P	2018	€ 5,25
270 mm	28	P	2019	€ 5,50
288 mm	30	P	2020	€ 6,00
306 mm	32	P	2021	€ 6,50
324 mm	34	P	2022	€ 7,00

Mat.	Order-No.	Price	Mat.	Order-No.	Price
A	1993	€ 4,00	A	1994	€ 4,25
A	1995	€ 4,50	A	1996	€ 4,75
A	1997	€ 5,00	A	1998	€ 5,25
A	1999	€ 5,50	A	2000	€ 5,75
A	2001	€ 6,00	A	2002	€ 6,25
A	2003	€ 6,50	A	2004	€ 6,75
A	2005	€ 7,25	A	2006	€ 7,85
A	2007	€ 8,35			

*Bei der Anzahl der Symbole ist berücksichtigt, dass immer 2 Außenelemente hinzu kommen.

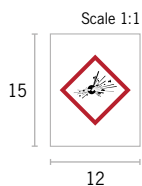

Gs GHS pictograms

Material		Quantity	Article		
Luxotherm® L / Aluminium, anodised A		10 pieces	0003		
Mat.	GHS 01	GHS 02	GHS 03	GHS 04	GHS 05
L	Order-No. 1246 Price € 1,65	Order-No. 1247 Price € 1,65	Order-No. 1248 Price € 1,65	Order-No. 1249 Price € 1,65	Order-No. 1250 Price € 1,65
A	Order-No. 1237 Price € 3,30	Order-No. 1238 Price € 3,30	Order-No. 1239 Price € 3,30	Order-No. 1240 Price € 3,30	Order-No. 1241 Price € 3,30
Mat.	GHS 06	GHS 07	GHS 08	GHS 09	
L	Order-No. 1251 Price € 1,65	Order-No. 1252 Price € 1,65	Order-No. 1253 Price € 1,65	Order-No. 1254 Price € 1,65	
A	Order-No. 1242 Price € 3,30	Order-No. 1243 Price € 3,30	Order-No. 1244 Price € 3,30	Order-No. 1245 Price € 3,30	

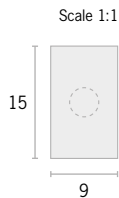

Oe Outer elements

Material	Quantity	Article
Luxotherm® L (yellow/black) L (white/black) / Aluminium, anodised A silver/black	15 pieces	0001

DIN 2403		No colour	Oxygen	Water	Steam	Air
Design	Mat.	Neutral	Group 0	Group 1	Group 2	Group 3
	L	41694 € 1,30	-	-	-	-
without hole	L	2110 € 1,30	2094 € 1,30	2096 € 1,30	2098 € 1,30	2100 € 1,30
	A	2090 € 2,40	2074 € 2,40	2076 € 2,40	2078 € 2,40	2080 € 2,40
	L	41695 € 1,30	-	-	-	-
with hole	L	2109 € 1,30	2093 € 1,30	2095 € 1,30	2097 € 1,30	2099 € 1,30
	A	2089 € 2,40	2073 € 2,40	2075 € 2,40	2077 € 2,40	2079 € 2,40

		Gases	Acids	Alkalis	Liquids and fixed materials	Additional colour
Design	Mat.	Group 4/5	Group 6	Group 7	Group 8/9	Zusatz
	L	2102 € 1,30	2104 € 1,30	2106 € 1,30	2108 € 1,30	2112 € 1,30
without hole	A	2082 € 2,40	2084 € 2,40	2086 € 2,40	2088 € 2,40	2092 € 2,40
	L	2101 € 1,30	2103 € 1,30	2105 € 1,30	2107 € 1,30	2111 € 1,30
with hole	A	2081 € 2,40	2083 € 2,40	2085 € 2,40	2087 € 2,40	2091 € 2,40

NEN 3050		No colour	Steam	Fire fighting	Gases and liquid gases	Alkalis
Design	Mat.	Neutral	Group 0	Group 1	Group 2	Group 3
	L	41694 € 1,30	-	-	-	-
without hole	L	2110 € 1,30	2144 € 1,30	2134 € 1,30	2136 € 1,30	2132 € 1,30
	A	2090 € 2,40	2126 € 2,40	2116 € 2,40	2118 € 2,40	2114 € 2,40
	L	41695 € 1,30	-	-	-	-
with hole	L	2109 € 1,30	2143 € 1,30	2133 € 1,30	2135 € 1,30	2131 € 1,30
	A	2089 € 2,40	2125 € 2,40	2115 € 2,40	2117 € 2,40	2113 € 2,40

		Air	Oils and flammable liquids	Acids	Acids	Other liquids
Design	Mat.	Group 4/5	Group 6	Group 7	Group 8/9	Zusatz
	L	2138 € 1,30	2140 € 1,30	2148 € 1,30	2146 € 1,30	2112 € 1,30
without hole	A	2120 € 2,40	2122 € 2,40	2130 € 2,40	2128 € 2,40	2092 € 2,40
	L	2137 € 1,30	2139 € 1,30	2147 € 1,30	2145 € 1,30	2111 € 1,30
with hole	A	2119 € 2,40	2121 € 2,40	2129 € 2,40	2127 € 2,40	2091 € 2,40

09 Series

Distance of observation 3 m

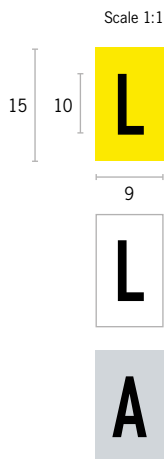

Sy Symbols

Material (c54)	Quantity	Article
Luxotherm® L (yellow/black) L (white/black) / Aluminium, anodised A silver/black	15 pieces	0003

Mat.	A	a	B	b	C	c	D	d	E	e
------	---	---	---	---	---	---	---	---	---	---

Order-No. L	1351	1417	1355	1421	1357	1423	1359	1425	1361	1427
Price	€ 1,30	€ 1,30	€ 1,30	€ 1,30	€ 1,30	€ 1,30	€ 1,30	€ 1,30	€ 1,30	€ 1,30
Order-No. L	1352	1418	1356	1422	1358	1424	1360	1426	1362	1428
Price	€ 1,30	€ 1,30	€ 1,30	€ 1,30	€ 1,30	€ 1,30	€ 1,30	€ 1,30	€ 1,30	€ 1,30
Order-No. A	1258	1291	1260	1293	1261	1294	1262	1295	1263	1296
Price	€ 2,40	€ 2,40	€ 2,40	€ 2,40	€ 2,40	€ 2,40	€ 2,40	€ 2,40	€ 2,40	€ 2,40

Mat.	F	f	G	g	H	h	I	i	J	j
------	---	---	---	---	---	---	---	---	---	---

Order-No. L	1363	1429	1365	1431	1367	1433	1369	1435	1371	1437
Price	€ 1,30	€ 1,30	€ 1,30	€ 1,30	€ 1,30	€ 1,30	€ 1,30	€ 1,30	€ 1,30	€ 1,30
Order-No. L	1364	1430	1366	1432	1368	1434	1370	1436	1372	1438
Price	€ 1,30	€ 1,30	€ 1,30	€ 1,30	€ 1,30	€ 1,30	€ 1,30	€ 1,30	€ 1,30	€ 1,30
Order-No. A	1264	1297	1265	1298	1266	1299	1267	1300	1268	1301
Price	€ 2,40	€ 2,40	€ 2,40	€ 2,40	€ 2,40	€ 2,40	€ 2,40	€ 2,40	€ 2,40	€ 2,40

Mat.	K	k	L	l	M	m	N	n	O	o
------	---	---	---	---	---	---	---	---	---	---

Order-No. L	1373	1439	1375	1441	1377	1443	1379	1445	1381	1447
Price	€ 1,30	€ 1,30	€ 1,30	€ 1,30	€ 1,30	€ 1,30	€ 1,30	€ 1,30	€ 1,30	€ 1,30
Order-No. L	1374	1440	1376	1442	1378	1444	1380	1446	1382	1448
Price	€ 1,30	€ 1,30	€ 1,30	€ 1,30	€ 1,30	€ 1,30	€ 1,30	€ 1,30	€ 1,30	€ 1,30
Order-No. A	1269	1302	1270	1303	1271	1304	1272	1305	1273	1306
Price	€ 2,40	€ 2,40	€ 2,40	€ 2,40	€ 2,40	€ 2,40	€ 2,40	€ 2,40	€ 2,40	€ 2,40

Mat.	P	p	Q	q	R	r	S	s	T	t
------	---	---	---	---	---	---	---	---	---	---

Order-No. L	1385	1451	1387	1453	1389	1455	1391	1457	1393	1459
Price	€ 1,30	€ 1,30	€ 1,30	€ 1,30	€ 1,30	€ 1,30	€ 1,30	€ 1,30	€ 1,30	€ 1,30
Order-No. L	1386	1452	1388	1454	1390	1456	1392	1458	1394	1460
Price	€ 1,30	€ 1,30	€ 1,30	€ 1,30	€ 1,30	€ 1,30	€ 1,30	€ 1,30	€ 1,30	€ 1,30
Order-No. A	1275	1308	1276	1309	1277	1310	1278	1311	1279	1312
Price	€ 2,40	€ 2,40	€ 2,40	€ 2,40	€ 2,40	€ 2,40	€ 2,40	€ 2,40	€ 2,40	€ 2,40

Mat.	U	u	V	v	W	w	X	x	Y	y
------	---	---	---	---	---	---	---	---	---	---

Order-No. L	1395	1461	1399	1465	1401	1467	1403	1469	1405	1471
Price	€ 1,30	€ 1,30	€ 1,30	€ 1,30	€ 1,30	€ 1,30	€ 1,30	€ 1,30	€ 1,30	€ 1,30
Order-No. L	1396	1462	1400	1466	1402	1468	1404	1470	1406	1472
Price	€ 1,30	€ 1,30	€ 1,30	€ 1,30	€ 1,30	€ 1,30	€ 1,30	€ 1,30	€ 1,30	€ 1,30
Order-No. A	1280	1313	1282	1315	1283	1316	1284	1317	1285	1318
Price	€ 2,40	€ 2,40	€ 2,40	€ 2,40	€ 2,40	€ 2,40	€ 2,40	€ 2,40	€ 2,40	€ 2,40

		Z	z	0	1	2	3	4	5	6	7
	Mat.										
Order-No.	L	1407	1473	1503	1505	1507	1509	1511	1513	1515	1517
Price		€ 1,30	€ 1,30	€ 1,30	€ 1,30	€ 1,30	€ 1,30	€ 1,30	€ 1,30	€ 1,30	€ 1,30
Order-No.	L	1408	1474	1504	1506	1508	1510	1512	1514	1516	1518
Price		€ 1,30	€ 1,30	€ 1,30	€ 1,30	€ 1,30	€ 1,30	€ 1,30	€ 1,30	€ 1,30	€ 1,30
Order-No.	A	1286	1319	1334	1335	1336	1337	1338	1339	1340	1341
Price		€ 2,40	€ 2,40	€ 2,40	€ 2,40	€ 2,40	€ 2,40	€ 2,40	€ 2,40	€ 2,40	€ 2,40

		8	9	2	2	3	3	4	4	!	:
	Mat.										
Order-No.	L	1519	1521	1409	1497	1411	1499	1413	1501	1345	1347
Price		€ 1,30	€ 1,30	€ 1,30	€ 1,30	€ 1,30	€ 1,30	€ 1,30	€ 1,30	€ 1,30	€ 1,30
Order-No.	L	1520	1522	1410	1498	1412	1500	1414	1502	1346	1348
Price		€ 1,30	€ 1,30	€ 1,30	€ 1,30	€ 1,30	€ 1,30	€ 1,30	€ 1,30	€ 1,30	€ 1,30
Order-No.	A	1342	1343	1287	1331	1288	1332	1289	1333	1255	1256
Price		€ 2,40	€ 2,40	€ 2,40	€ 2,40	€ 2,40	€ 2,40	€ 2,40	€ 2,40	€ 2,40	€ 2,40

		=	+	()	,	.	-	▶	▲	±
	Mat.										
Order-No.	L	1349	1489	1415	1475	1477	1493	1481	1483	1485	1487
Price		€ 1,30	€ 1,30	€ 1,30	€ 1,30	€ 1,30	€ 1,30	€ 1,30	€ 1,30	€ 1,30	€ 1,30
Order-No.	L	1350	1490	1416	1476	1478	1494	1482	1484	1486	1488
Price		€ 1,30	€ 1,30	€ 1,30	€ 1,30	€ 1,30	€ 1,30	€ 1,30	€ 1,30	€ 1,30	€ 1,30
Order-No.	A	1257	1327	1290	1320	1321	1329	1323	1324	1325	1326
Price		€ 2,40	€ 2,40	€ 2,40	€ 2,40	€ 2,40	€ 2,40	€ 2,40	€ 2,40	€ 2,40	€ 2,40

		%	/	..	
	Mat.				
Order-No.	L	1491	1495	1523	1479
Price		€ 1,30	€ 1,30	€ 1,30	€ 1,30
Order-No.	L	1492	1496	1524	1480
Price		€ 1,30	€ 1,30	€ 1,30	€ 1,30
Order-No.	A	1328	1330	1344	1322
Price		€ 2,40	€ 2,40	€ 2,40	€ 2,40

18 Series

Distance of observation 9 m

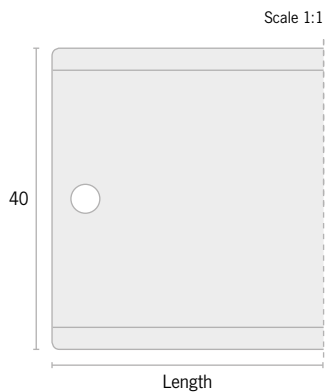

Sp Slide-in profiles

Material		Quantity	Article
Chlorid free plastic P / Aluminium, anodised A		5 pieces	0002
Length	Number of symbols*	Mat.	Mat.
72 mm	2 / 3**	Order-No. P 6782 Price € 3,20	Order-No. A 6778 Price € 4,65
90 mm	3 / 4**	Order-No. P 6783 Price € 3,50	Order-No. A 6779 Price € 4,95
108 mm	4 / 5**	Order-No. P 6784 Price € 3,80	Order-No. A 6780 Price € 5,25
126 mm	5 / 6**	Order-No. P 6785 Price € 4,10	Order-No. A 6781 Price € 5,55
144 mm	6 / 7**	Order-No. P 2036 Price € 4,40	Order-No. A 2023 Price € 5,85
162 mm	7 / 8**	Order-No. P 2037 Price € 4,70	Order-No. A 2024 Price € 6,15
180 mm	8 / 9**	Order-No. P 2038 Price € 5,00	Order-No. A 2025 Price € 6,45
198 mm	9 / 10**	Order-No. P 2039 Price € 5,30	Order-No. A 2026 Price € 6,75
216 mm	10 / 11**	Order-No. P 2040 Price € 5,60	Order-No. A 2027 Price € 7,05
234 mm	11 / 12**	Order-No. P 2041 Price € 5,90	Order-No. A 2028 Price € 7,35
252 mm	12 / 13**	Order-No. P 2042 Price € 6,20	Order-No. A 2029 Price € 7,75
270 mm	13 / 14**	Order-No. P 2043 Price € 6,50	Order-No. A 2030 Price € 8,05
288 mm	14 / 15**	Order-No. P 2044 Price € 6,80	Order-No. A 2031 Price € 8,35
306 mm	15 / 16**	Order-No. P 2045 Price € 7,10	Order-No. A 2032 Price € 8,65
324 mm	16 / 17**	Order-No. P 2046 Price € 7,80	Order-No. A 2033 Price € 9,25
342 mm	17 / 18**	Order-No. P 2047 Price € 8,40	Order-No. A 2034 Price € 9,85
360 mm	18 / 19**	Order-No. P 2048 Price € 9,00	Order-No. A 2035 Price € 10,45

*The number of symbols takes into account that there are always two additional outer elements.

**With half outer elements

Gs GHS pictograms

Material	Quantity	Article
Luxotherm® L / Aluminium, anodised A	10 pieces	0003

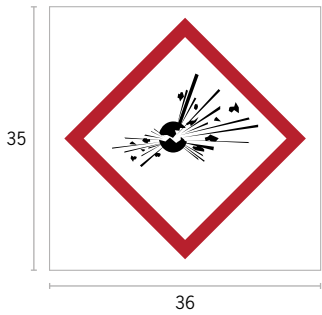
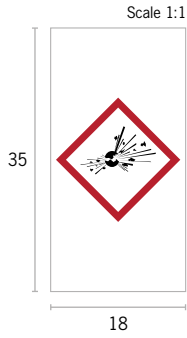

GHS 01	
Mat.	18 mm 36 mm
Order-No.	1624 33305
Price	€ 2,55 € 4,55
Order-No.	1525 33296
Price	€ 5,10 € 8,90



GHS 02	
Mat.	18 mm 36 mm
Order-No.	1625 33306
Price	€ 2,55 € 4,55
Order-No.	1526 33297
Price	€ 5,10 € 8,90



GHS 03	
Mat.	18 mm 36 mm
Order-No.	1626 33307
Price	€ 2,55 € 4,55
Order-No.	1527 33298
Price	€ 5,10 € 8,90



GHS 04	
Mat.	18 mm 36 mm
Order-No.	1627 33308
Price	€ 2,55 € 4,55
Order-No.	1528 33299
Price	€ 5,10 € 8,90



GHS 05	
Mat.	18 mm 36 mm
Order-No.	1628 33309
Price	€ 2,55 € 4,55
Order-No.	1529 33300
Price	€ 5,10 € 8,90



GHS 06	
Mat.	18 mm 36 mm
Order-No.	1629 33310
Price	€ 2,55 € 4,55
Order-No.	1530 33301
Price	€ 5,10 € 8,90



GHS 07	
Mat.	18 mm 36 mm
Order-No.	1630 33311
Price	€ 2,55 € 4,55
Order-No.	1531 33302
Price	€ 5,10 € 8,90



GHS 08	
Mat.	18 mm 36 mm
Order-No.	1631 33312
Price	€ 2,55 € 4,55
Order-No.	1532 33303
Price	€ 5,10 € 8,90



GHS 09	
Mat.	18 mm 36 mm
Order-No.	1632 33313
Price	€ 2,55 € 4,55
Order-No.	1533 33304
Price	€ 5,10 € 8,90

18 Series

Distance of observation 9 m



Gs GHS double pictograms

Material	Quantity	Article
Luxotherm® L / Aluminium, anodised A	10 pieces	0003

Mat.	GHS 01/02	GHS 01/05	GHS 01/06	GHS 01/07	GHS 01/08	GHS 01/09
Order-No. L	36548	36549	36550	36551	36552	36553
Price	€ 2,55	€ 2,55	€ 2,55	€ 2,55	€ 2,55	€ 2,55
Order-No. A	36523	36524	36525	36526	36527	36528
Price	€ 5,10	€ 5,10	€ 5,10	€ 5,10	€ 5,10	€ 5,10

Mat.	GHS 02/05	GHS 02/06	GHS 02/07	GHS 02/08	GHS 02/09
Order-No. L	36554	36555	36556	36557	36558
Price	€ 2,55	€ 2,55	€ 2,55	€ 2,55	€ 2,55
Order-No. A	36529	36530	36531	36532	36533
Price	€ 5,10	€ 5,10	€ 5,10	€ 5,10	€ 5,10

Mat.	GHS 03/05	GHS 03/06	GHS 03/07	GHS 03/08	GHS 03/09
Order-No. L	36559	36560	36561	36562	36563
Price	€ 2,55	€ 2,55	€ 2,55	€ 2,55	€ 2,55
Order-No. A	36534	36535	36536	36537	36538
Price	€ 5,10	€ 5,10	€ 5,10	€ 5,10	€ 5,10

Mat.	GHS 05/06	GHS 05/07	GHS 05/08	GHS 05/09
Order-No. L	36564	36565	36566	36567
Price	€ 2,55	€ 2,55	€ 2,55	€ 2,55
Order-No. A	36539	36540	36541	36542
Price	€ 5,10	€ 5,10	€ 5,10	€ 5,10

Mat.	GHS 06/08	GHS 06/09	GHS 07/08	GHS 07/09	GHS 08/09
Order-No. L	36568	36569	36570	36571	36572
Price	€ 2,55	€ 2,55	€ 2,55	€ 2,55	€ 2,55
Order-No. A	36543	36544	36545	36546	36547
Price	€ 5,10	€ 5,10	€ 5,10	€ 5,10	€ 5,10

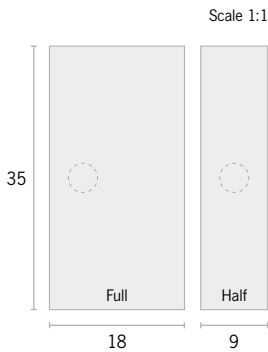

Oe Outer Elements

Material	Quantity	Article
Luxotherm® L (yellow/black) L (white/black) / Aluminium, anodised A silver/black	10 pcs. (full) / 15 pcs. (half)	0001

DIN 2403		No colour		Oxygen		Water		Steam		Air	
Design	Mat.	Neutral		Group 0		Group 1		Group 2		Group 3	
	L	41696	41698	-	-	-	-	-	-	-	-
		€ 2,10	€ 2,45								
without hole	L	2186	2298	2170	2282	2172	2284	2174	2286	2176	2288
		€ 2,10	€ 2,45	€ 2,10	€ 2,45	€ 2,10	€ 2,45	€ 2,10	€ 2,45	€ 2,10	€ 2,45
	A	2166	2278	2150	2262	2152	2264	2154	2266	2156	2268
		€ 4,00	€ 4,80	€ 4,00	€ 4,80	€ 4,00	€ 4,80	€ 4,00	€ 4,80	€ 4,00	€ 4,80
with hole	L	41697	41699	-	-	-	-	-	-	-	-
		€ 2,10	€ 2,45								
	L	2185	2297	2169	2281	2171	2283	2173	2285	2175	2287
		€ 2,10	€ 2,45	€ 2,10	€ 2,45	€ 2,10	€ 2,45	€ 2,10	€ 2,45	€ 2,10	€ 2,45
	A	2165	2277	2149	2261	2151	2263	2153	2265	2155	2267
		€ 4,00	€ 4,80	€ 4,00	€ 4,80	€ 4,00	€ 4,80	€ 4,00	€ 4,80	€ 4,00	€ 4,80

Gases		Acids		Alkalis		Liquids and fixed materials		Additional Colour			
Design	Mat.	Group 4/5		Group 6		Group 7		Group 8/9		Zusatz	
	L	2178	2290	2180	2292	2182	2294	2184	2296	2188	2300
		€ 2,10	€ 2,45	€ 2,10	€ 2,45	€ 2,10	€ 2,45	€ 2,10	€ 2,45	€ 2,10	€ 2,45
without hole	A	2158	2270	2160	2272	2162	2274	2164	2276	2168	2280
		€ 4,00	€ 4,80	€ 4,00	€ 4,80	€ 4,00	€ 4,80	€ 4,00	€ 4,80	€ 4,00	€ 4,80
with hole	L	2177	2289	2179	2291	2181	2293	2183	2295	2187	2299
		€ 2,10	€ 2,45	€ 2,10	€ 2,45	€ 2,10	€ 2,45	€ 2,10	€ 2,45	€ 2,10	€ 2,45
	A	2157	2269	2159	2271	2161	2273	2163	2275	2167	2279
		€ 4,00	€ 4,80	€ 4,00	€ 4,80	€ 4,00	€ 4,80	€ 4,00	€ 4,80	€ 4,00	€ 4,80

NEN 3050		No colour		Steam		Fire fighting		Gases and liquid gases		Alkalis	
Design	Mat.	Neutral		RAL9006		RAL3000		RAL1004		RAL4001	
	L	41696	41698	-	-	-	-	-	-	-	-
		€ 2,10	€ 2,45								
without hole	L	2186	2298	2220	2256	2210	2246	2212	2248	2208	2244
		€ 2,10	€ 2,45	€ 2,10	€ 2,45	€ 2,10	€ 2,45	€ 2,10	€ 2,45	€ 2,10	€ 2,45
	A	2166	2278	2202	2238	2192	2228	2194	2230	2190	2226
		€ 4,00	€ 4,80	€ 4,00	€ 4,80	€ 4,00	€ 4,80	€ 4,00	€ 4,80	€ 4,00	€ 4,80
with hole	L	41697	41699	-	-	-	-	-	-	-	-
		€ 2,10	€ 2,45								
	L	2185	2297	2219	2255	2209	2245	2211	2247	2207	2243
		€ 2,10	€ 2,45	€ 2,10	€ 2,45	€ 2,10	€ 2,45	€ 2,10	€ 2,45	€ 2,10	€ 2,45
	A	2165	2277	2201	2237	2191	2227	2193	2229	2189	2225
		€ 4,00	€ 4,50	€ 4,00	€ 4,80	€ 4,00	€ 4,80	€ 4,00	€ 4,80	€ 4,00	€ 4,80

Air		Oils and flammable liquids		Acids		Water		Other liquids			
Design	Mat.	RAL5012		RAL8001		RAL2008		RAL6010		Black	
	L	2214	2250	2216	2252	2224	2260	2222	2258	2188	2300
		€ 2,10	€ 2,45	€ 2,10	€ 2,45	€ 2,10	€ 2,45	€ 2,10	€ 2,45	€ 2,10	€ 2,45
without hole	A	2196	2232	2198	2234	2206	2242	2204	2240	2168	2280
		€ 4,00	€ 4,80	€ 4,00	€ 4,80	€ 4,00	€ 4,80	€ 4,00	€ 4,80	€ 4,00	€ 4,80
with hole	L	2213	2249	2215	2251	2223	2259	2221	2257	2187	2299
		€ 2,10	€ 2,45	€ 2,10	€ 2,45	€ 2,10	€ 2,45	€ 2,10	€ 2,45	€ 2,10	€ 2,45
	A	2195	2231	2197	2233	2205	2241	2203	2239	2167	2279
		€ 4,00	€ 4,80	€ 4,00	€ 4,80	€ 4,00	€ 4,80	€ 4,00	€ 4,80	€ 4,00	€ 4,80

18 Series

Erkennungsweite 9 Meter

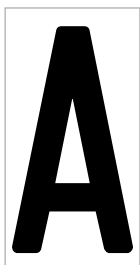
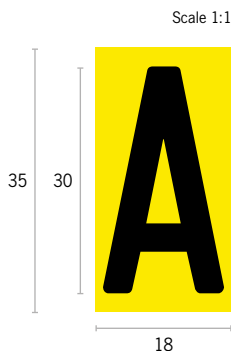

Sy Symbols

	Material (colours)	Quantity	Article
	Luxotherm® L (yellow/black) L (white/black) / Aluminium, anodised A silver/black	10 pieces	0003

	A	a	B	b	C	c	D	d	E	e
Mat.										
Order-No.	L 1639	1705	1643	1709	1645	1711	1647	1713	1649	1715
Price	€ 2,10	€ 2,10	€ 2,10	€ 2,10	€ 2,10	€ 2,10	€ 2,10	€ 2,10	€ 2,10	€ 2,10
Order-No.	L 1640	1706	1644	1710	1646	1712	1648	1714	1650	1716
Price	€ 2,10	€ 2,10	€ 2,10	€ 2,10	€ 2,10	€ 2,10	€ 2,10	€ 2,10	€ 2,10	€ 2,10
Order-No.	A 1537	1570	1539	1572	1540	1573	1541	1574	1542	1575
Price	€ 4,20	€ 4,20	€ 4,20	€ 4,20	€ 4,20	€ 4,20	€ 4,20	€ 4,20	€ 4,20	€ 4,20

	F	f	G	g	H	h	I	i	J	j
Mat.										
Order-No.	L 1651	1717	1653	1719	1655	1721	1657	1723	1659	1725
Price	€ 2,10	€ 2,10	€ 2,10	€ 2,10	€ 2,10	€ 2,10	€ 2,10	€ 2,10	€ 2,10	€ 2,10
Order-No.	L 1652	1718	1654	1720	1656	1722	1658	1724	1660	1726
Price	€ 2,10	€ 2,10	€ 2,10	€ 2,10	€ 2,10	€ 2,10	€ 2,10	€ 2,10	€ 2,10	€ 2,10
Order-No.	A 1543	1576	1544	1577	1545	1578	1546	1579	1547	1580
Price	€ 4,20	€ 4,20	€ 4,20	€ 4,20	€ 4,20	€ 4,20	€ 4,20	€ 4,20	€ 4,20	€ 4,20

	K	k	L	l	M	m	N	n	O	o
Mat.										
Order-No.	L 1661	1727	1663	1729	1665	1731	1667	1733	1669	1735
Price	€ 2,10	€ 2,10	€ 2,10	€ 2,10	€ 2,10	€ 2,10	€ 2,10	€ 2,10	€ 2,10	€ 2,10
Order-No.	L 1662	1728	1664	1730	1666	1732	1668	1734	1670	1736
Price	€ 2,10	€ 2,10	€ 2,10	€ 2,10	€ 2,10	€ 2,10	€ 2,10	€ 2,10	€ 2,10	€ 2,10
Order-No.	A 1548	1581	1549	1582	1550	1583	1551	1584	1552	1585
Price	€ 4,20	€ 4,20	€ 4,20	€ 4,20	€ 4,20	€ 4,20	€ 4,20	€ 4,20	€ 4,20	€ 4,20

	P	p	Q	q	R	r	S	s	T	t
Mat.										
Order-No.	L 1673	1739	1675	1741	1677	1743	1679	1745	1681	1747
Price	€ 2,10	€ 2,10	€ 2,10	€ 2,10	€ 2,10	€ 2,10	€ 2,10	€ 2,10	€ 2,10	€ 2,10
Order-No.	L 1674	1740	1676	1742	1678	1744	1680	1746	1682	1748
Price	€ 2,10	€ 2,10	€ 2,10	€ 2,10	€ 2,10	€ 2,10	€ 2,10	€ 2,10	€ 2,10	€ 2,10
Order-No.	A 1554	1587	1555	1588	1556	1589	1557	1590	1558	1591
Price	€ 4,20	€ 4,20	€ 4,20	€ 4,20	€ 4,20	€ 4,20	€ 4,20	€ 4,20	€ 4,20	€ 4,20

	U	u	V	v	W	w	X	x	Y	y
Mat.										
Order-No.	L 1683	1749	1687	1753	1689	1755	1691	1757	1693	1759
Price	€ 2,10	€ 2,10	€ 2,10	€ 2,10	€ 2,10	€ 2,10	€ 2,10	€ 2,10	€ 2,10	€ 2,10
Order-No.	L 1684	1750	1688	1754	1690	1756	1692	1758	1694	1760
Price	€ 2,10	€ 2,10	€ 2,10	€ 2,10	€ 2,10	€ 2,10	€ 2,10	€ 2,10	€ 2,10	€ 2,10
Order-No.	A 1559	1592	1561	1594	1562	1595	1563	1596	1564	1597
Price	€ 4,20	€ 4,20	€ 4,20	€ 4,20	€ 4,20	€ 4,20	€ 4,20	€ 4,20	€ 4,20	€ 4,20

	Z	z	0	1	2	3	4	5	6	7
<i>Mat.</i>										
Order-No.	L 1695	1761	1791	1793	1795	1797	1799	1801	1803	1805
Price	€ 2,10	€ 2,10	€ 2,10	€ 2,10	€ 2,10	€ 2,10	€ 2,10	€ 2,10	€ 2,10	€ 2,10
Order-No.	L 1696	1762	1792	1794	1796	1798	1800	1802	1804	1806
Price	€ 2,10	€ 2,10	€ 2,10	€ 2,10	€ 2,10	€ 2,10	€ 2,10	€ 2,10	€ 2,10	€ 2,10
Order-No.	A 1565	1598	1613	1614	1615	1616	1617	1618	1619	1620
Price	€ 4,20	€ 4,20	€ 4,20	€ 4,20	€ 4,20	€ 4,20	€ 4,20	€ 4,20	€ 4,20	€ 4,20

	8	9	2	2	3	3	4	4	!	:
<i>Mat.</i>										
Order-No.	L 1807	1809	1697	1785	1699	1787	1701	1789	1633	1635
Price	€ 2,10	€ 2,10	€ 2,10	€ 2,10	€ 2,10	€ 2,10	€ 2,10	€ 2,10	€ 2,10	€ 2,10
Order-No.	L 1808	1810	1698	1786	1700	1788	1702	1790	1634	1636
Price	€ 2,10	€ 2,10	€ 2,10	€ 2,10	€ 2,10	€ 2,10	€ 2,10	€ 2,10	€ 2,10	€ 2,10
Order-No.	A 1621	1622	1566	1610	1567	1611	1568	1612	1534	1535
Price	€ 4,20	€ 4,20	€ 4,20	€ 4,20	€ 4,20	€ 4,20	€ 4,20	€ 4,20	€ 4,20	€ 4,20

	=	+	()	,	.	-	▶	▲	◀
<i>Mat.</i>										
Order-No.	L 1637	1777	1703	1763	1765	1781	1769	1771	1773	30303
Price	€ 2,10	€ 2,10	€ 2,10	€ 2,10	€ 2,10	€ 2,10	€ 2,10	€ 2,10	€ 2,10	€ 2,10
Order-No.	L 1638	1778	1704	1764	1766	1782	1770	1772	1774	30301
Price	€ 2,10	€ 2,10	€ 2,10	€ 2,10	€ 2,10	€ 2,10	€ 2,10	€ 2,10	€ 2,10	€ 2,10
Order-No.	A 1536	1606	1569	1599	1600	1608	1602	1603	1604	30299
Price	€ 4,20	€ 4,20	€ 4,20	€ 4,20	€ 4,20	€ 4,20	€ 4,20	€ 4,20	€ 4,20	€ 4,20

	◄	±	%	/	"	
<i>Mat.</i>						
Order-No.	L 30304	1775	1779	1783	1811	1767
Price	€ 2,10	€ 2,10	€ 2,10	€ 2,10	€ 2,10	€ 2,10
Order-No.	L 30302	1776	1780	1784	1812	1768
Price	€ 2,10	€ 2,10	€ 2,10	€ 2,10	€ 2,10	€ 2,10
Order-No.	A 30300	1605	1607	1609	1623	1601
Price	€ 4,20	€ 4,20	€ 4,20	€ 4,20	€ 4,20	€ 4,20

Printed and Engraved Signs

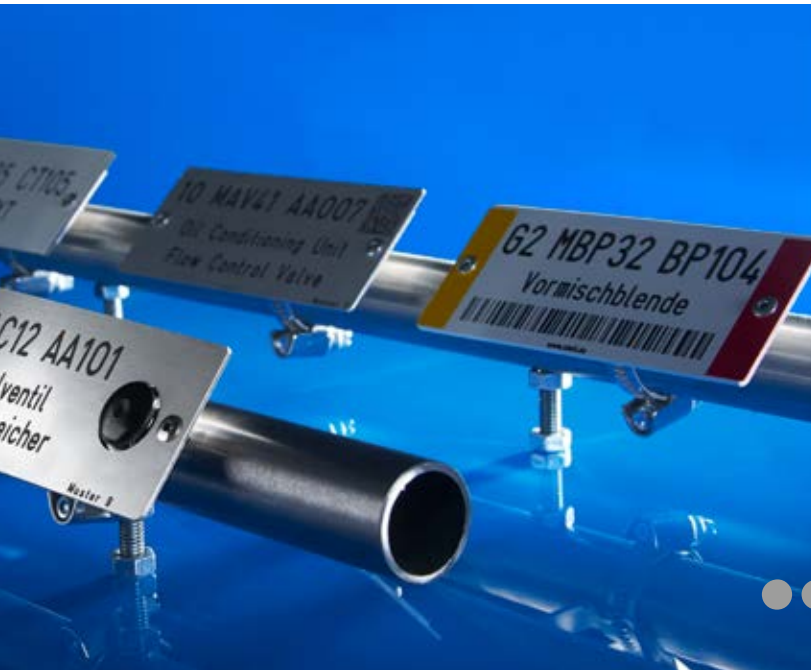

When we talk about signs, we are usually referring to engraved or printed signs for plant labelling. Both versions are available in a variety of basic materials, the standard sizes are perfectly matched to our fastenings, and they can be provided with data components such as QR codes or RFID. The location's conditions serve as the determining factor in selecting the material and the production process.

Printed Signs

Fast production even with large quantities. Our machines can process a multitude of substrates with a wide variety of colour systems. These range from conventional solvent-based colours to multi-component colours and lacquers with extreme resistance to external influences through UV-hardening paints. Additionally, we offer a wide selection of printable materials, among them conventional polyvinyl chloride, various metals, plastics and acrylates. This way, new and frequently used contents can be combined by making use of a multitude of implementation variants.

Engraved Signs

The classic when it comes to price-performance ratio. Simple and long-lasting labelling, even in temperature critical areas. Our in-house production allows us to offer cost-effective engraving and short-term delivery times. Through milling, machine engraving and laser engraving, we are able to cleanly and precisely label all plastic and metal signs. We offer about 80 different basic materials, surface textures and colour tones for you to choose from. When engraving and milling metals, the contrast in the material can also be significantly increased by the colouring of the milling groove.



Scale 1:1

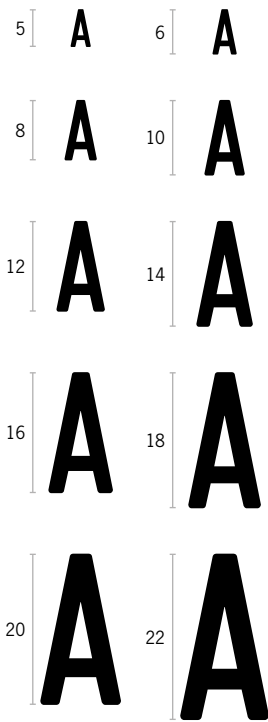

Character count and distance of observation

Coding and text message represent the essence of a sign. The required length of the text depends on the desired, resp. the required height of the text and the resulting length of the sign.

Font height (mm)	5	6	8	10	12	14	16	18	20	22				
Distance of observation (m)	1,5	1,8	2,4	3	3,6	4,2	4,8	5,4	6	6,6				
Length (mm)	Height (mm)			Character count per line*										
74 mm	22	42	-	with hole	20	17	13	10	9	7	6	6	5	5
				without hole	24	20	15	12	10	8	7	7	6	6
92 mm	22	42	62	with hole	26	22	17	13	11	9	8	8	6	6
				without hole	30	25	19	15	12	10	9	9	7	7
110 mm	22	42	62	with hole	32	27	21	16	13	11	10	10	7	7
				without hole	36	30	23	18	14	12	11	11	8	8
128 mm	22	42	62	with hole	38	32	25	19	15	13	12	12	9	9
				without hole	42	35	27	21	16	14	13	13	10	10
146 mm	-	42	62	with hole	44	37	29	22	17	15	14	14	11	11
				without hole	48	40	31	23	18	16	15	15	12	12
164 mm	-	42	62	with hole	50	42	33	25	19	17	16	16	13	13
				without hole	54	45	35	27	20	18	17	17	14	14

*Stated values are approximate values that can vary, depending on font. Standard font is DIN 1451.

Standard sizes for printed and engraved signs

Below mentioned standard sizes match our fastening systems and tools. However, different sizes are available upon request.

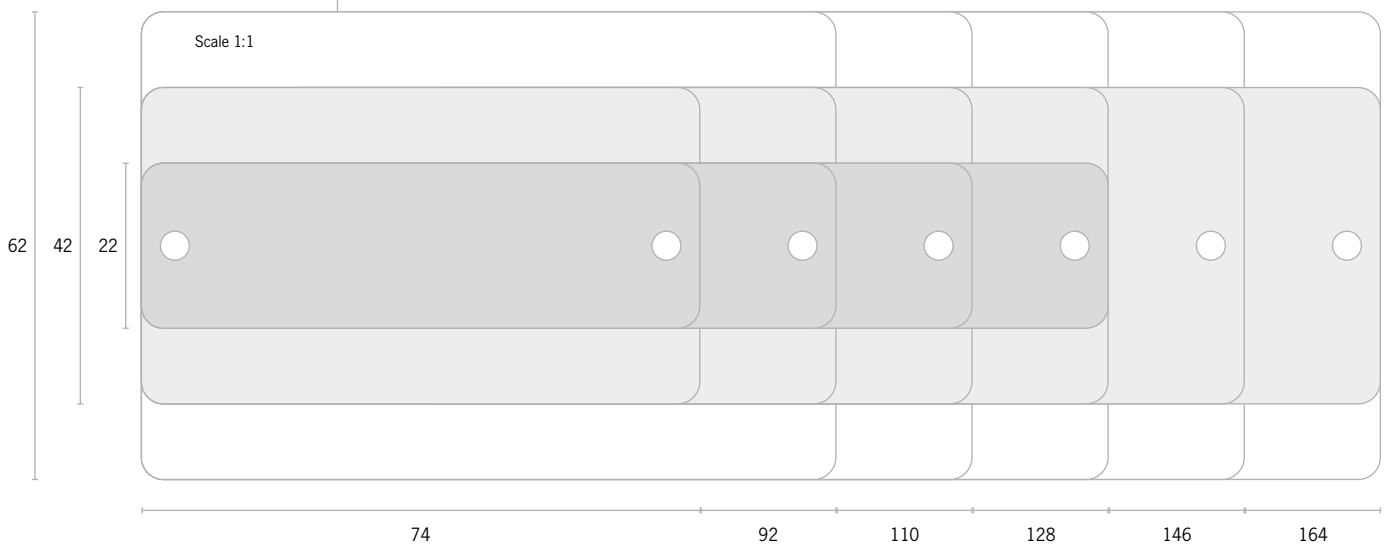

InSTELLigent Products – Signs with Barcode, Data Matrix and RFID



In addition to the optical information on our signs, electronically readable information is applied to them as a reference. Both our printed and engraved signs can contain an OCR font, a barcode or a Data Matrix as integral part of the print, resp. engraving. Additionally, the usage of RFID technology is an interesting option for the industries of our customers. These intelligent signs come in all sorts of shapes and represent interfaces for maintenance and servicing works of plants and plant parts and the automated identification on pipes, networks and components. We can offer you an extensive selection of signs and basic materials to create your individual interface, so please do not hesitate to get in contact with us.

Data Matrix / OCR Code

The QR code, which is used often nowadays, can be especially well recognised by simple terminal devices, therefore offering an extensive range of applications. Even in rough environments, it is not very susceptible to contamination or scratching and it can still be read if up to 25% of it is damaged. The most important aspect for reliable readability is a suitable contrast between the background and the Data Matrix which mainly depends on the on-site lighting conditions.

RFID

A step further with regard to automation and data exchange are RFID transponders. The RFID technology allows (process) information to be read, stored and overwritten in the transponder (at the installation location in the plant) without any physical contact. Any sign equipped with an RFID transponder can thus be uniquely identified without exception. Excellent adhesive quality and resistance also make our RFID signs suitable for use in harsher environments. And if you want to take this technology to the next level you should consider our new high-tech sign with integrated transponder – the R2D2 sign.

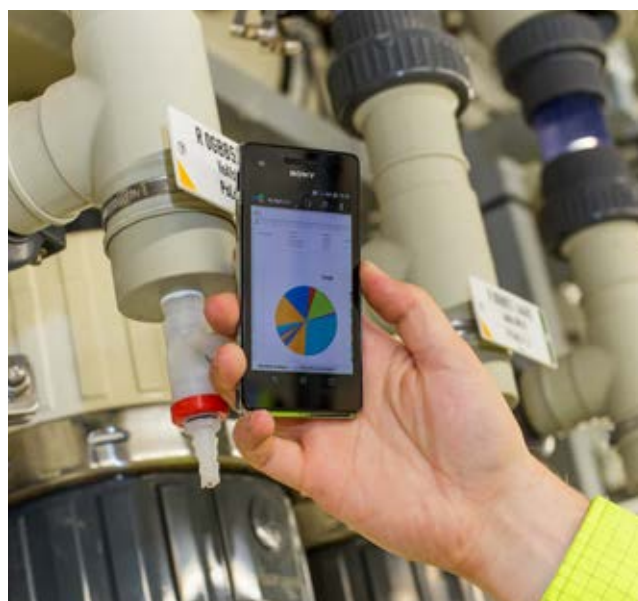

R2D2 – Ran-in RFID Durable Datasign

Our patented R2D2 sign has been developed to offer digital interfaces for all plant areas even in harsh conditions. One solution for any kind of intended usage.

R2D2 consists of reinforced high-performance plastic in which an RFID transponder is permanently embedded. The basic material can be engraved or printed so it represents a perfect advancement of already existing labelling means. Thanks to the combination of implemented materials and production method and the fixed connection between the transponder and the sign, R2D2 is likely to be today's most resilient intelligent labelling solution. To get the most out of the R2D2 technology we've adjusted the production method so that all signs will undergo a complete automated check. This way we can guarantee that the visual and digital information of the sign is always identical, ensuring the most important aspect of safe automatization – 100% reliability.

The benefits of R2D2 at a glance:

- Clear identification with a worldwide unique serial number
- 30 years of data security
- Standard frequency range of 13.56 MHz
- Guaranteed 100% match between text and data
- Temperature resistance from -40 °C to 150 °C
- Permanently embedded RFID transponder
- Excellent writing and reading qualities
- No shielding effects from metal (MoM)
- Very good resistance to UV radiation
- Good resistance to acid and chemicals
- Perfectly matched to our fastening systems



Standard sizes of R2D2-signs

Scale 1:1



Slide-In System



The slide-in system combines the advantages of the original Stell “Stecksystem” and the product range for engraved and printed signs. Comprised of a slide-in profile, an engraved or printed insert as well as insertable symbols, it offers you flexibility and increased information density.

The printed or engraved signs are inserted into a slide-in profile and contain customer-specific information on plant operation and the pipe sequence, or additional information on test circuits, pipe pressure or the addresses. In addition, the flow direction, GHS pictograms, colours, etc. are slid and riveted as standard elements in alignment with our standard sizes. The slide-in system is particularly suitable for our customers who would like to personally handle and change their labeling, but at the same time want to show a lot of concentrated on-site information.



18 series
Slide-in profile = 144 mm, half outer elements

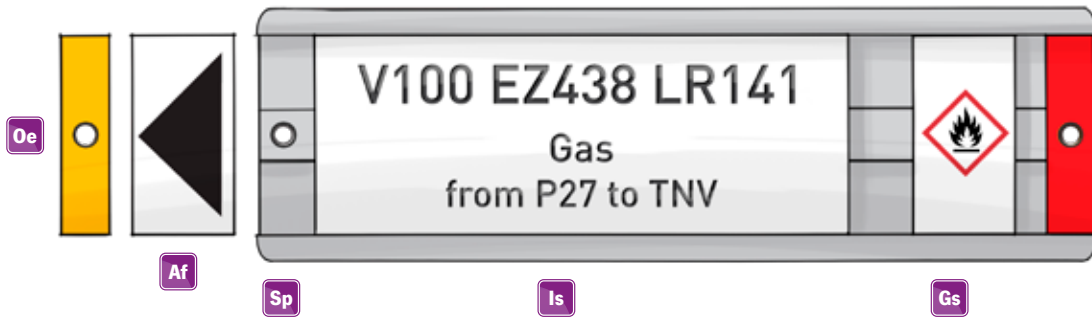

Sign bracket = 142 x 18 mm

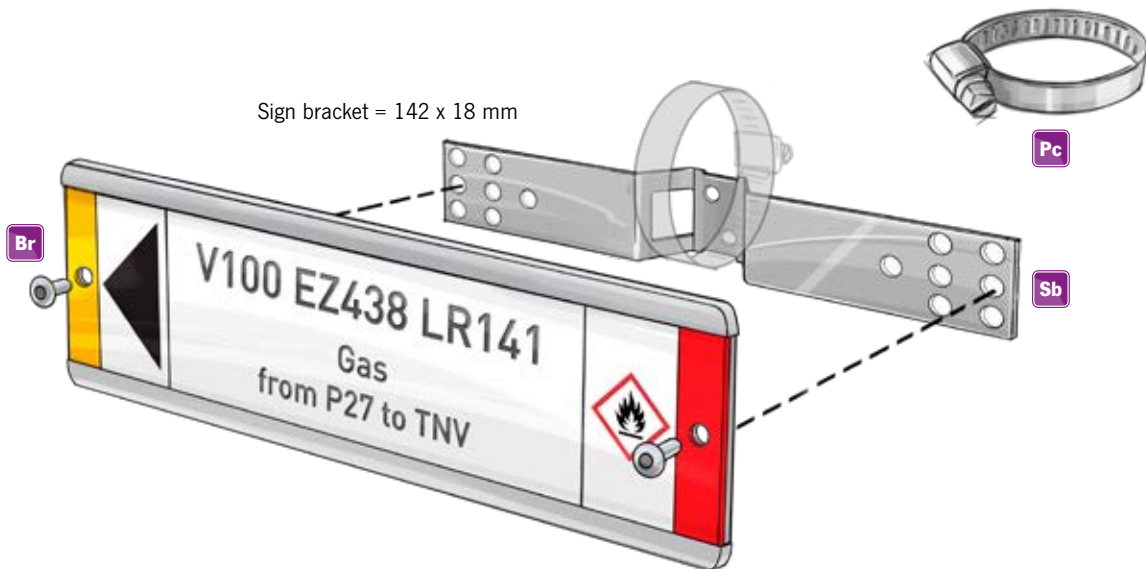

- | | | | |
|--|---|--|---------------------------------------|
| Is Inserts
See page 37, 37, 37, 37 | Oe Outer elements
See page 37, 37, 37, 37 | Af Flow direction arrows
See page 37, 37, 37, 37 | Pc Pipe clamps
See page 37 |
| Sp Slide-in profiles
See page 37, 37, 37, 37 | Gs GHS pictograms
See page 37, 37, 37, 37 | Sb Sign brackets
See page 37 | Br Blind rivets
See page 37 |

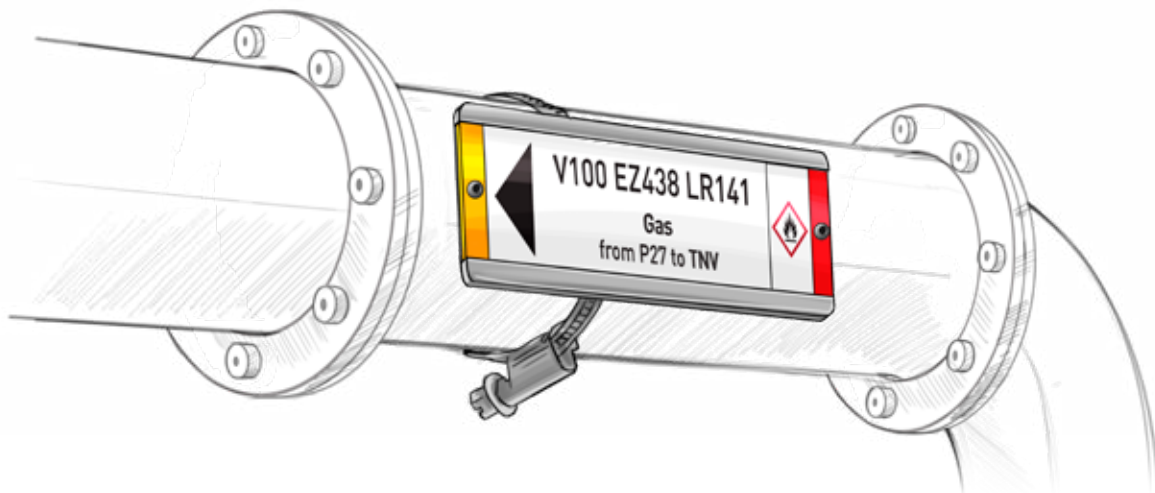

Is Inserts

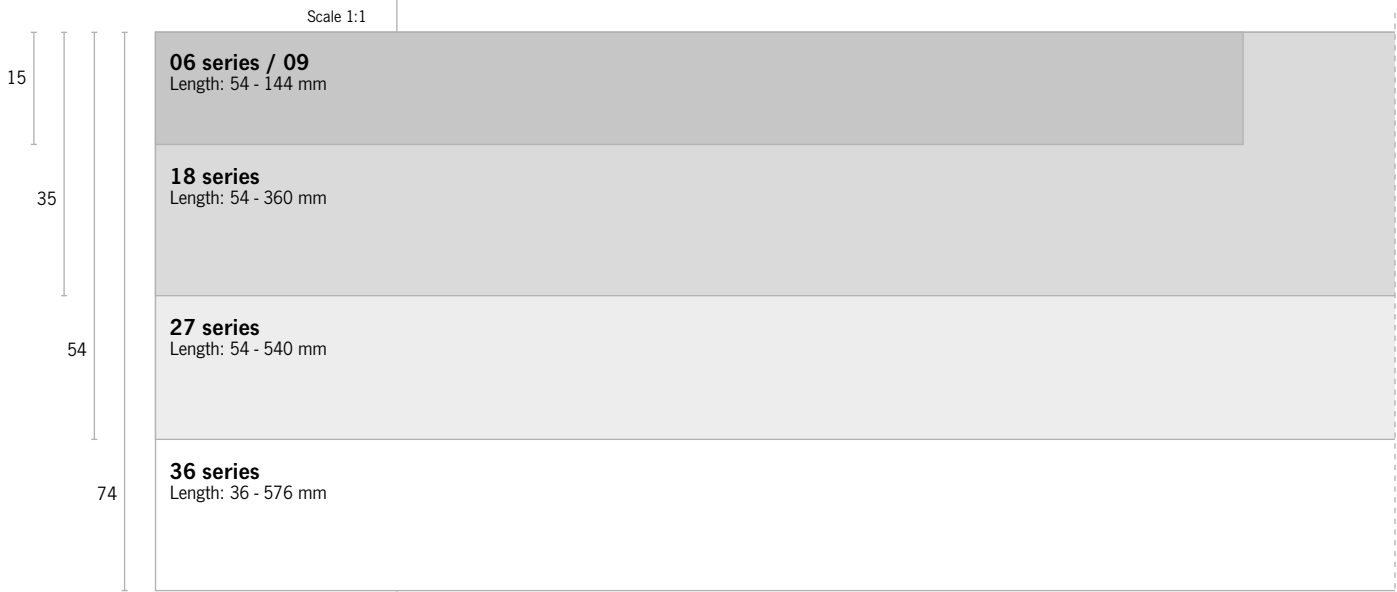
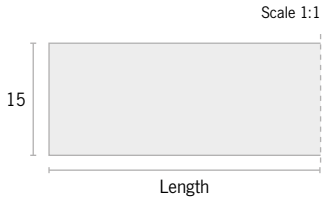

Scale 1:1

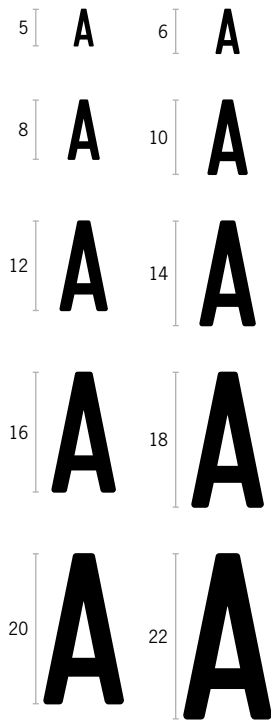

Letter count and distance of observation

Coding and text message represent the essence of a sign. The required length of the text depends on the desired, resp. the required height of the text and the resulting length of the sign. The following overview shows the relevant proportions for engraved and printed signs.

Font height (mm)	5	6	8	10	12	14	16	18	20	22
Distance of observation (m)	1,5	1,8	2,4	3	3,6	4,2	4,8	5,4	6	6,6

Serie ▶	06/09 18 27 36				Character count per line**													
Length of inserts	Height of inserts (mm)																	
36 mm	-	-	-	74	11	9	7	5	4	3	3	3	2	2				
54 mm	15	35	54	74	17	14	10	8	7	6	5	4	4	3				
72 mm	15	35	54	74	23	19	14	11	9	8	7	6	5	5				
81 mm	-	-	54	-	26	21	16	13	10	9	8	7	6	5				
90 mm	15	35	54	74	29	24	18	14	12	10	9	8	7	6				
99 mm	-	35	54	-	32	26	20	16	13	11	10	8	8	7				
108 mm	15	35	54	74	35	29	21	17	14	12	10	9	8	7				
117 mm	-	35	54	-	37	31	23	18	15	13	12	10	9	8				
126 mm	15	35	54	74	40	34	25	20	17	14	12	11	10	9				
135 mm	-	35	54	-	43	36	27	21	18	15	13	12	10	9				
144 mm	15	35	-	74	46	38	29	23	19	16	14	12	11	10				
153 mm	-	35	54	-	49	41	30	24	20	17	15	13	12	11				
162 mm	-	35	54	74	52	43	32	26	21	18	16	14	13	11				
171 mm	-	35	54	-	55	46	34	27	23	19	17	15	13	12				
180 mm	-	35	54	74	58	48	36	29	24	20	18	16	14	13				
189 mm	-	35	54	-	61	51	38	30	25	21	19	17	15	13				
198 mm	-	35	54	74	64	53	40	32	26	22	20	17	16	14				
207 mm	-	35	54	-	67	55	41	33	27	23	20	18	16	15				
216 mm	-	35	54	74	69	58	43	34	29	24	21	19	17	15				
225 mm	-	35	54	-	72	60	45	36	30	26	22	20	18	16				
234 mm	-	35	54	74	75	63	47	37	31	27	23	21	18	17				
243 mm	-	35	54	-	78	65	49	39	32	28	24	21	19	17				
252 mm	-	35	54	74	81	68	51	40	34	29	25	22	20	18				
261 mm	-	35	54	-	84	70	52	42	35	30	26	23	21	19				
270 mm	-	35	54	74	87	72	54	43	36	31	27	24	21	19				
279 mm	-	35	54	-	90	75	56	45	37	32	28	25	22	20				
288 mm	-	35	54	74	93	77	58	46	38	33	29	25	23	21				
297 mm	-	35	54	-	96	80	60	48	40	34	30	26	24	21				
306 mm	-	35	54	74	99	82	61	49	41	35	31	27	24	22				
315 mm	-	35	54	-	101	85	63	51	42	36	31	28	25	23				
324 mm	-	35	54	74	104	87	65	52	43	37	32	29	26	23				
333 mm	-	35	54	-	107	90	67	53	45	38	33	29	26	24				
342 mm	-	35	54	74	111	92	69	55	46	39	34	30	27	25				
351 mm	-	35	54	-	113	94	71	56	47	40	35	31	28	25				
360 mm	-	-	-	74	116	97	72	58	48	41	36	32	29	26				
369 mm	-	-	54	-	119	99	74	59	49	42	37	33	29	27				
378 mm	-	-	54	-	122	102	76	61	51	43	38	34	30	27				
396 mm	-	-	-	74	129	107	80	64	53	45	40	35	31	28				
405 mm	-	-	54	-	131	109	81	65	54	46	41	36	32	29				
414 mm	-	-	54	-	133	111	83	67	55	47	41	37	33	30				
432 mm	-	-	54	74	139	116	87	70	58	50	43	38	35	31				
441 mm	-	-	54	-	142	119	89	71	59	51	44	39	35	32				
450 mm	-	-	54	74	145	121	91	72	60	52	45	40	36	33				
459 mm	-	-	54	-	148	124	92	74	62	53	46	41	37	33				
468 mm	-	-	54	74	151	127	94	75	63	54	47	42	37	34				
477 mm	-	-	54	-	154	128	96	77	64	55	48	42	38	35				
486 mm	-	-	54	-	157	131	98	78	65	56	49	43	39	35				
504 mm	-	-	54	74	163	136	102	81	67	58	51	45	40	37				
513 mm	-	-	54	-	166	138	103	83	69	59	51	46	41	37				
540 mm	-	-	54	74	174	145	109	87	72	62	54	48	43	39				
576 mm	-	-	-	74	186	155	116	93	77	66	58	51	46	42				

*Stated values are approximate values that can vary, depending on font. Standard font is DIN 1451.

Please note: The max. character count might vary due to the different shapes of the characters. As standard for calculation, the letter "G" had been set for the fonts listed on the right side.

06/09 Series

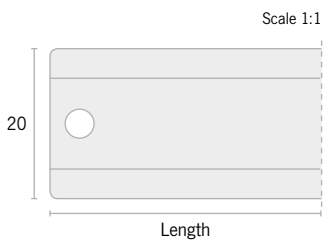
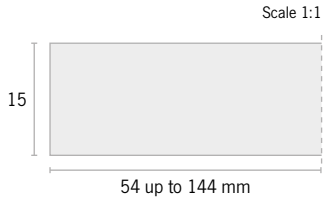

Is Inserts

Standard sizes 54 up to 144 mm. Other sizes and prices on request.

Sp Slide-in profiles

Material		Quantity	Article			
Chlorid free plastic P / Aluminium, anodised A		5 pieces	0002			
Length	Length of insert*	Order-No.	Price	Mat.	Article	Price
72 mm	54 mm	P 2008	€ 2,75	A	1993	€ 4,00
90 mm	72 mm	P 2009	€ 3,00	A	1994	€ 4,25
108 mm	90 mm	P 2010	€ 3,25	A	1995	€ 4,50
126 mm	108 mm	P 2011	€ 3,50	A	1996	€ 4,75
144 mm	126 mm	P 2012	€ 3,75	A	1997	€ 5,00
162 mm	144 mm	P 2013	€ 4,00	A	1998	€ 5,25

*The number of symbols takes into account that there are always two additional outer elements.

Fastening: see page 65

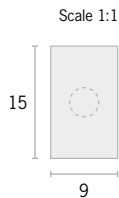

Oe Outer elements

Material	Quantity	Article
Luxotherm® L / Aluminium, anodised A	15 pieces	0001

		DIN 2403		Oxygen	Water	Steam	Air
		No colour		RAL5005	RAL6032	RAL3001	RAL7004
Design	Mat.	Neutral	Group 0	Group 1	Group 2	Group 3	
without hole	Order-No. L	2110	2094	2096	2097	2100	
	Price	€ 1,30	€ 1,30	€ 1,30	€ 1,30	€ 1,30	
without hole	Order-No. A	2090	2074	2076	2078	2080	
	Price	€ 2,40	€ 2,40	€ 2,40	€ 2,40	€ 2,40	
with hole	Order-No. L	2109	2093	2095	2097	2099	
	Price	€ 1,30	€ 1,30	€ 1,30	€ 1,30	€ 1,30	
with hole	Order-No. A	2089	2073	2075	2077	2079	
	Price	€ 2,40	€ 2,40	€ 2,40	€ 2,40	€ 2,40	

		Gases	Acids	Alkalis	Liquids and fixed materials	Additional Colour
		RAL1003	RAL2010	RAL4008	RAL8002	Black
Design	Mat.	Group 4/5	Group 6	Group 7	Group 8/9	Zusatz
without hole	Order-No. L	2102	2104	2106	2108	2112
	Price	€ 1,30	€ 1,30	€ 1,30	€ 1,30	€ 1,30
without hole	Order-No. A	2082	2084	2086	2088	2092
	Price	€ 2,40	€ 2,40	€ 2,40	€ 2,40	€ 2,40
with hole	Order-No. L	2101	2103	2105	2107	2111
	Price	€ 1,30	€ 1,30	€ 1,30	€ 1,30	€ 1,30
with hole	Order-No. A	2081	2083	2085	2087	2091
	Price	€ 2,40	€ 2,40	€ 2,40	€ 2,40	€ 2,40

		NEN 3050		Steam	Fire Fighting	Gases and Liquid Gases	Alkalis
		No colour		RAL9006	RAL3000	RAL1004	RAL4001
Design	Mat.						
without hole	Order-No. L	2110	2144	2134	2136	2132	
	Price	€ 1,30	€ 1,30	€ 1,30	€ 1,30	€ 1,30	
without hole	Order-No. A	2090	2126	2116	2118	2114	
	Price	€ 2,40	€ 2,40	€ 2,40	€ 2,40	€ 2,40	
with hole	Order-No. L	2109	2143	2133	2135	2131	
	Price	€ 1,30	€ 1,30	€ 1,30	€ 1,30	€ 1,30	
with hole	Order-No. A	2089	2125	2115	2117	2113	
	Price	€ 2,40	€ 2,40	€ 2,40	€ 2,40	€ 2,40	

		Air	Oils and flammable liquids	Acids	Water	Other Liquids
		RAL5012	RAL8001	RAL2008	RAL6010	Black
Design	Mat.					
without hole	Order-No. L	2138	2140	2148	2146	2112
	Price	€ 1,30	€ 1,30	€ 1,30	€ 1,30	€ 1,30
without hole	Order-No. A	2120	2122	2130	2128	2092
	Price	€ 2,40	€ 2,40	€ 2,40	€ 2,40	€ 2,40
with hole	Order-No. L	2137	2139	2147	2145	2111
	Price	€ 1,30	€ 1,30	€ 1,30	€ 1,30	€ 1,30
with hole	Order-No. A	2119	2121	2129	2127	2091
	Price	€ 2,40	€ 2,40	€ 2,40	€ 2,40	€ 2,40

06/09 Series



Gs GHS pictograms

Material	Quantity	Article
Luxotherm® L / Aluminium, anodised A	10 pieces	0003

	GHS 01	GHS 02	GHS 03	GHS 04	GHS 05
<i>Mat.</i>					
Order-No. L	1246	1247	1248	1249	1250
Price	€ 1,65	€ 1,65	€ 1,65	€ 1,65	€ 1,65
Order-No. A	1237	1238	1239	1240	1241
Price	€ 3,30	€ 3,30	€ 3,30	€ 3,30	€ 3,30
<i>Mat.</i>					
Order-No. L	1251	1252	1253	1254	
Price	€ 1,65	€ 1,65	€ 1,65	€ 1,65	
Order-No. A	1242	1243	1244	1245	
Price	€ 3,30	€ 3,30	€ 3,30	€ 3,30	

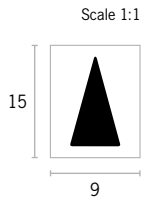

Af Flow direction arrows

Material	Quantity	Article
Luxotherm® L / Aluminium, anodised A	15 pieces	0003

<i>Mat.</i>		
Order-No. L	1484	1486
Price	€ 1,30	€ 1,30
Order-No. A	1324	1325
Price	€ 2,40	€ 2,40

18 Series

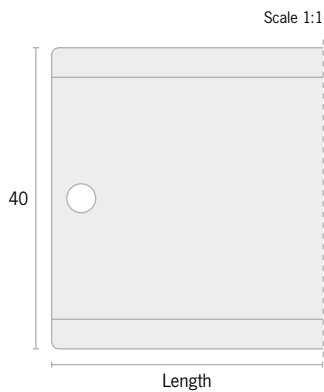

Is Inserts

Standardgrößen 54 bis zu 360 mm. Andere Größen und Preise sind auf Anfrage erhältlich.

Sp Slide-in profiles

Material		Quantity	Article
Chlorid free plastic P / Aluminium, anodised A		5 pieces	0002
Length	Length of insert*	Mat.	Mat.
72 mm	- / 54** mm	Order-No. P 6782 Price € 3,20	A 6778 € 4,65
90 mm	54 / 72** mm	Order-No. P 6783 Price € 3,50	A 6779 € 4,95
108 mm	72 / 90** mm	Order-No. P 6784 Price € 3,80	A 6780 € 5,25
126 mm	90 / 108** mm	Order-No. P 6785 Price € 4,10	A 6781 € 5,55
144 mm	108 / 126** mm	Order-No. P 2036 Price € 4,40	A 2023 € 5,85
162 mm	126 / 144** mm	Order-No. P 2037 Price € 4,70	A 2024 € 6,15
180 mm	144 / 162** mm	Order-No. P 2038 Price € 5,00	A 2025 € 6,45
198 mm	162 / 180** mm	Order-No. P 2039 Price € 5,30	A 2026 € 6,75
216 mm	180 / 198** mm	Order-No. P 2040 Price € 5,60	A 2027 € 7,05
234 mm	198 / 216** mm	Order-No. P 2041 Price € 5,90	A 2028 € 7,35
252 mm	216 / 234** mm	Order-No. P 2042 Price € 6,20	A 2029 € 7,75
270 mm	234 / 252** mm	Order-No. P 2043 Price € 6,50	A 2030 € 8,05
288 mm	252 / 270** mm	Order-No. P 2044 Price € 6,80	A 2031 € 8,35
306 mm	270 / 288** mm	Order-No. P 2045 Price € 7,10	A 2032 € 8,65
324 mm	288 / 306** mm	Order-No. P 2046 Price € 7,80	A 2033 € 9,25
342 mm	306 / 324** mm	Order-No. P 2047 Price € 8,40	A 2034 € 9,85
360 mm	324 / 342** mm	Order-No. P 2048 Price € 9,00	A 2035 € 10,45

* The number of symbols takes into account that there are always two additional outer elements.
** With half outer elements

Fastening: see page 65

18 Series

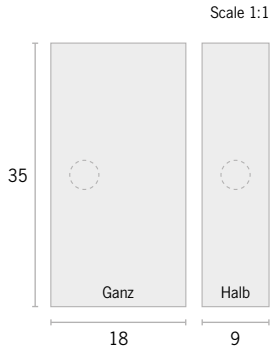

Oe Outer Elements

Material	Quantity	Article
Luxotherm® L / Aluminium, anodised A	10 pieces (full) / 15 pieces (half)	0001

DIN 2403		No colour		Oxygen RAL5005		Water RAL6032		Steam RAL3001		Air RAL7004	
Design	Mat.	Neutral		Group 0		Group 1		Group 2		Group 3	
without hole	Order-No. L	2186	2298	2170	2282	2172	2284	2174	2286	2176	2288
	Price A	€ 2,10	€ 2,45	€ 2,10	€ 2,45	€ 2,10	€ 2,45	€ 2,10	€ 2,45	€ 2,10	€ 2,45
with hole	Order-No. L	2166	2278	2150	2262	2152	2264	2154	2266	2156	2268
	Price A	€ 4,00	€ 4,80	€ 4,00	€ 4,80	€ 4,00	€ 4,80	€ 4,00	€ 4,80	€ 4,00	€ 4,80

Gases RAL1003		Acids RAL2010		Alkalis RAL4008		Liquids and fixed materials RAL8002		Additional Colour Black			
Design	Mat.	Group 4/5		Group 6		Group 7		Group 8/9		Zusatz	
without hole	Order-No. L	2178	2290	2180	2292	2182	2294	2184	2296	2188	2300
	Price A	€ 2,10	€ 2,45	€ 2,10	€ 2,45	€ 2,10	€ 2,45	€ 2,10	€ 2,45	€ 2,10	€ 2,45
with hole	Order-No. L	2158	2270	2160	2272	2162	2274	2164	2276	2168	2280
	Price A	€ 4,00	€ 4,80	€ 4,00	€ 4,80	€ 4,00	€ 4,80	€ 4,00	€ 4,80	€ 4,00	€ 4,50

NEN 3050		No colour		Steam RAL9006		Fire fighting RAL3000		Gases and liquid gases RAL1004		Alkalis RAL4001	
Design	Mat.										
without hole	Order-No. L	2186	2298	2220	2256	2210	2246	2212	2248	2208	2244
	Price A	€ 2,10	€ 2,45	€ 2,10	€ 2,45	€ 2,10	€ 2,45	€ 2,10	€ 2,45	€ 2,10	€ 2,45
with hole	Order-No. L	2166	2278	2202	2238	2192	2228	2194	2230	2190	2226
	Price A	€ 4,00	€ 4,80	€ 4,00	€ 4,80	€ 4,00	€ 4,80	€ 4,00	€ 4,80	€ 4,00	€ 4,80

Air RAL5012		Oils and flammable liquids RAL8001		Acids RAL2008		Water RAL6010		Other liquids Black			
Design	Mat.										
without hole	Order-No. L	2214	2250	2216	2252	2224	2260	2222	2258	2188	2300
	Price A	€ 2,10	€ 2,45	€ 2,10	€ 2,45	€ 2,10	€ 2,45	€ 2,10	€ 2,45	€ 2,10	€ 2,45
with hole	Order-No. L	2196	2232	2198	2234	2206	2242	2204	2240	2168	2280
	Price A	€ 4,00	€ 4,80	€ 4,00	€ 4,80	€ 4,00	€ 4,80	€ 4,00	€ 4,80	€ 4,00	€ 4,80

Scale 1:1

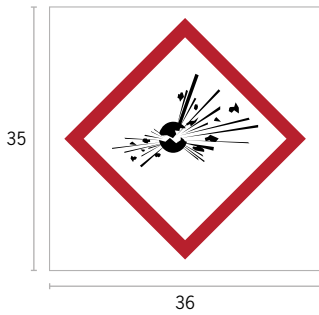
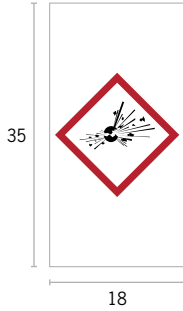

Scale 1:1

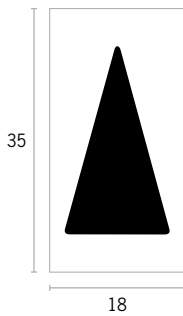

Gs GHS pictograms

Material		Quantity	Article
Luxotherm® L / Aluminium, anodised A		10 pieces	0003

	Mat.	GHS 01		GHS 02		GHS 03		GHS 04		GHS 05	
		18 mm	36 mm	18 mm	36 mm	18 mm	36 mm	18 mm	36 mm	18 mm	36 mm
Order-No.	L	1624	33305	1625	33306	1626	33307	1627	33308	1628	33309
Price	L	€ 2,55	€ 4,55	€ 2,55	€ 4,55	€ 2,55	€ 4,55	€ 2,55	€ 4,55	€ 2,55	€ 4,55
Order-No.	A	1525	33296	1526	33297	1527	33298	1528	33299	1529	33300
Price	A	€ 5,10	€ 8,90	€ 5,10	€ 8,90	€ 5,10	€ 8,90	€ 5,10	€ 8,90	€ 5,10	€ 8,90

	Mat.	GHS 06		GHS 07		GHS 08		GHS 09	
		18 mm	36 mm	18 mm	36 mm	18 mm	36 mm	18 mm	36 mm
Order-No.	L	1629	33310	1630	33311	1631	33312	1632	33313
Price	L	€ 2,55	€ 4,55	€ 2,55	€ 4,55	€ 2,55	€ 4,55	€ 2,55	€ 4,55
Order-No.	A	1530	33301	1531	33302	1532	33303	1533	33304
Price	A	€ 5,10	€ 8,90	€ 5,10	€ 8,90	€ 5,10	€ 8,90	€ 5,10	€ 8,90

Af Flow direction arrows

Material		Quantity	Article
Luxotherm® L / Aluminium, anodised A		10 pieces	0003

	Mat.	Flow direction arrow 1		Flow direction arrow 2		Flow direction arrow 3		Flow direction arrow 4	
		18 mm	36 mm	18 mm	36 mm	18 mm	36 mm	18 mm	36 mm
Order-No.	L	1772	1774	30301	30302	30301	30302	30301	30302
Price	L	€ 2,10	€ 2,10	€ 2,10	€ 2,10	€ 2,10	€ 2,10	€ 2,10	€ 2,10
Order-No.	A	1603	1604	30299	30300	30299	30300	30300	30300
Price	A	€ 4,20	€ 4,20	€ 4,20	€ 4,20	€ 4,20	€ 4,20	€ 4,20	€ 4,20

18 Series

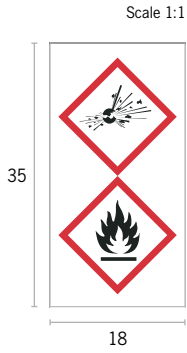

Gs GHS double pictograms

Material	Quantity	Article
Luxotherm® L / Aluminium, anodised A	10 pieces	0003

	GHS 01/02	GHS 01/05	GHS 01/06	GHS 01/07	GHS 01/08	GHS 01/09
<i>Mat.</i>						
Order-No. L	36548	36549	36550	36551	36552	36553
Price	€ 2,55	€ 2,55	€ 2,55	€ 2,55	€ 2,55	€ 2,55
Order-No. A	36523	36524	36525	36526	36527	36528
Price	€ 5,10	€ 5,10	€ 5,10	€ 5,10	€ 5,10	€ 5,10

	GHS 02/05	GHS 02/06	GHS 02/07	GHS 02/08	GHS 02/09
<i>Mat.</i>					
Order-No. L	36554	36555	36556	36557	36558
Price	€ 2,55	€ 2,55	€ 2,55	€ 2,55	€ 2,55
Order-No. A	36529	36530	36531	36532	36533
Price	€ 5,10	€ 5,10	€ 5,10	€ 5,10	€ 5,10

	GHS 03/05	GHS 03/06	GHS 03/07	GHS 03/08	GHS 03/09
<i>Mat.</i>					
Order-No. L	36559	36560	36561	36562	36563
Price	€ 2,55	€ 2,55	€ 2,55	€ 2,55	€ 2,55
Order-No. A	36534	36535	36536	36537	36538
Price	€ 5,10	€ 5,10	€ 5,10	€ 5,10	€ 5,10

	GHS 05/06	GHS 05/07	GHS 05/08	GHS 05/09
<i>Mat.</i>				
Order-No. L	36564	36565	36566	36567
Price	€ 2,55	€ 2,55	€ 2,55	€ 2,55
Order-No. A	36539	36540	36541	36542
Price	€ 5,10	€ 5,10	€ 5,10	€ 5,10

	GHS 06/08	GHS 06/09	GHS 07/08	GHS 07/09	GHS 08/09
<i>Mat.</i>					
Order-No. L	36568	36569	36570	36571	36572
Price	€ 2,55	€ 2,55	€ 2,55	€ 2,55	€ 2,55
Order-No. A	36543	36544	36545	36546	36547
Price	€ 5,10	€ 5,10	€ 5,10	€ 5,10	€ 5,10

27 Series

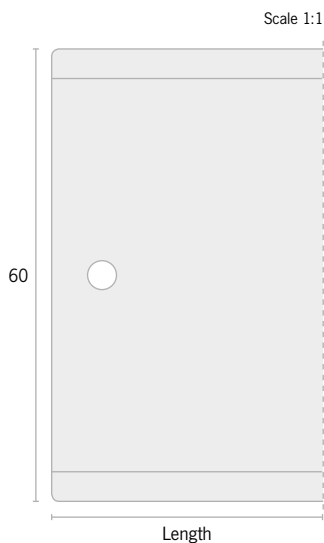
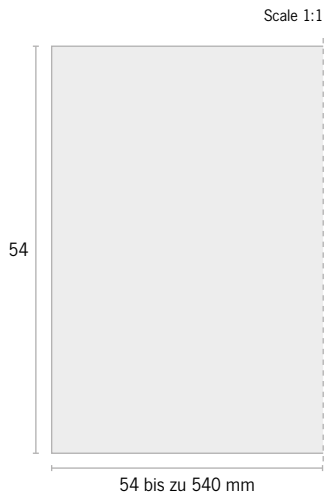

Is Inserts

Standard sizes 54 up to 540 mm. Other sizes and prices on request.

Sp Slide-in profiles

Material	Quantity	Article
Chlorid free plastic P / Aluminium, anodised A	5 pieces	0008

Length	Length of insert*	Order-No.	Price	Mat.	Order-No.	Price	Mat.
108 mm	54 / 81** mm	P 6812	€ 4,30	A 6794		€ 6,30	
126 mm	72 / 99** mm	P 22066	€ 4,65	A 22059		€ 6,40	
144 mm	90 / 117** mm	P 22067	€ 5,00	A 22060		€ 6,75	
162 mm	108 / 135** mm	P 544	€ 5,35	A 536		€ 7,35	
180 mm	126 / 153** mm	P 22068	€ 5,70	A 22061		€ 7,80	
198 mm	144 / 171** mm	P 22069	€ 6,05	A 22062		€ 8,15	
216 mm	162 / 189** mm	P 545	€ 6,40	A 537		€ 8,50	
234 mm	180 / 207** mm	P 22070	€ 6,75	A 22063		€ 8,85	
252 mm	198 / 225** mm	P 22071	€ 7,10	A 22064		€ 9,20	
270 mm	216 / 243** mm	P 546	€ 7,45	A 538		€ 9,55	
288 mm	234 / 261** mm	P 6813	€ 7,90	A 6795		€ 10,10	
306 mm	252 / 279** mm	P 6814	€ 8,25	A 6796		€ 10,65	
324 mm	270 / 297** mm	P 547	€ 8,60	A 539		€ 11,20	
342 mm	288 / 315** mm	P 6815	€ 8,95	A 6797		€ 11,75	
360 mm	306 / 333** mm	P 6816	€ 9,30	A 6798		€ 12,30	
378 mm	324 / 351** mm	P 548	€ 9,65	A 540		€ 12,85	
396 mm	342 / 369** mm	P 6817	€ 10,00	A 6799		€ 13,40	
432 mm	378 / 405** mm	P 549	€ 10,25	A 541		€ 13,95	
468 mm	414 / 441** mm	P 6818	€ 10,70	A 6800		€ 14,50	
486 mm	432 / 459** mm	P 550	€ 11,40	A 542		€ 16,75	
504 mm	450 / 477** mm	P 6819	€ 12,10	A 6801		€ 17,85	
540 mm	486 / 513** mm	P 551	€ 12,80	A 543		€ 18,95	

* The number of symbols takes into account that there are always two additional outer elements.
 ** With half outer elements

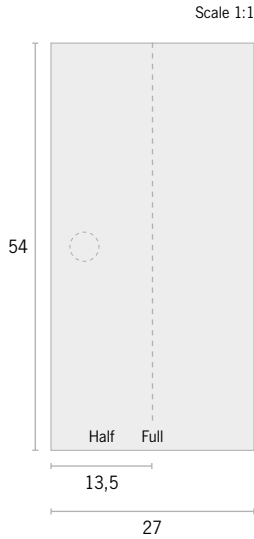

Oe Outer elements

Material	Quantity	Article
Luxotherm® L / Aluminium, anodised A	10 pieces	0007

		DIN 2403		No colour		Oxygen		Water		Steam		Air	
		RAL1003		RAL5005		RAL6032		RAL3001		RAL7004			
		Group 4/5		Group 0		Group 1		Group 2		Group 3			
Design	Mat.	Ganz	Halb	Ganz	Halb	Ganz	Halb	Ganz	Halb	Ganz	Halb	Ganz	Halb
without hole	Order-No. L	619	20921	603	20905	605	20907	607	20909	609	20911		
	Price	€ 2,60	€ 3,10	€ 2,60	€ 3,10	€ 2,60	€ 3,10	€ 2,60	€ 3,10	€ 2,60	€ 3,10		
with hole	Order-No. A	599	20901	583	20885	585	20887	587	20889	589	20891		
	Price	€ 5,10	€ 6,10	€ 5,10	€ 6,10	€ 5,10	€ 6,10	€ 5,10	€ 6,10	€ 5,10	€ 6,10		
without hole	Order-No. L	618	20920	602	20904	604	20906	606	20908	608	20910		
	Price	€ 2,60	€ 3,10	€ 2,60	€ 3,10	€ 2,60	€ 3,10	€ 2,60	€ 3,10	€ 2,60	€ 3,10		
with hole	Order-No. A	598	20900	582	20884	584	20886	586	20888	588	20890		
	Price	€ 5,10	€ 6,10	€ 5,10	€ 6,10	€ 5,10	€ 6,10	€ 5,10	€ 6,10	€ 5,10	€ 6,10		

		Gases		Acids		Alkalis		Liquids and fixed materials		Additional colour			
		RAL1003		RAL2010		RAL4008		RAL8002		Black			
		Group 4/5		Group 6		Group 7		Group 8/9		Zusatz			
Design	Mat.	Ganz	Halb	Ganz	Halb	Ganz	Halb	Ganz	Halb	Ganz	Halb	Ganz	Halb
without hole	Order-No. L	611	20913	613	20915	615	20917	617	20919	621	20923		
	Price	€ 2,60	€ 3,10	€ 2,60	€ 3,10	€ 2,60	€ 3,10	€ 2,60	€ 3,10	€ 2,40	€ 3,10		
with hole	Order-No. A	591	20893	593	20895	595	20897	597	20899	601	20903		
	Price	€ 5,10	€ 6,10	€ 5,10	€ 6,10	€ 5,10	€ 6,10	€ 5,10	€ 6,10	€ 4,80	€ 6,10		
without hole	Order-No. L	610	20912	612	20914	614	20916	616	20918	620	20922		
	Price	€ 2,60	€ 3,10	€ 2,60	€ 3,10	€ 2,60	€ 3,10	€ 2,60	€ 3,10	€ 2,40	€ 3,10		
with hole	Order-No. A	590	20892	592	20894	594	20896	596	20898	600	20902		
	Price	€ 5,10	€ 6,10	€ 5,10	€ 6,10	€ 5,10	€ 6,10	€ 5,10	€ 6,10	€ 4,80	€ 6,10		

		NEN 3050		No colour		Steam		Fire fighting		Gases and liquids gases		Alkalis	
		RAL9006		RAL3000		RAL1004		RAL4001					
Design	Mat.	Ganz	Halb	Ganz	Halb	Ganz	Halb	Ganz	Halb	Ganz	Halb	Ganz	Halb
without hole	Order-No. L	619	20921	653	20955	643	20945	645	20947	641	20943		
	Price	€ 2,60	€ 3,10	€ 2,60	€ 3,10	€ 2,60	€ 3,10	€ 2,60	€ 3,10	€ 2,60	€ 3,10		
with hole	Order-No. A	599	20901	635	20937	625	20927	627	20929	623	20925		
	Price	€ 5,10	€ 6,10	€ 5,10	€ 6,10	€ 5,10	€ 6,10	€ 5,10	€ 6,10	€ 5,10	€ 6,10		
without hole	Order-No. L	618	20920	652	20954	642	20944	644	20946	640	20942		
	Price	€ 2,60	€ 3,10	€ 2,60	€ 3,10	€ 2,60	€ 3,10	€ 2,60	€ 3,10	€ 2,60	€ 3,10		
with hole	Order-No. A	598	20900	634	20936	624	20926	626	20928	622	20924		
	Price	€ 5,10	€ 6,10	€ 5,10	€ 6,10	€ 5,10	€ 6,10	€ 5,10	€ 6,10	€ 5,10	€ 6,10		

		Air		Oils and other flammable liquids		Acids		Water		Other liquids			
		RAL5012		RAL8001		RAL2008		RAL6010		Black			
Design	Mat.	Ganz	Halb	Ganz	Halb	Ganz	Halb	Ganz	Halb	Ganz	Halb	Ganz	Halb
without hole	Order-No. L	647	20949	649	20951	657	20959	655	20957	621	20923		
	Price	€ 2,60	€ 3,10	€ 2,60	€ 3,10	€ 2,60	€ 3,10	€ 2,60	€ 3,10	€ 2,40	€ 3,10		
with hole	Order-No. A	629	20931	631	20933	639	20941	637	20939	601	20903		
	Price	€ 5,10	€ 6,10	€ 5,10	€ 6,10	€ 5,10	€ 6,10	€ 5,10	€ 6,10	€ 4,80	€ 6,10		
without hole	Order-No. L	646	20948	648	20950	656	20958	654	20956	620	20922		
	Price	€ 2,60	€ 3,10	€ 2,60	€ 3,10	€ 2,60	€ 3,10	€ 2,60	€ 3,10	€ 2,40	€ 3,10		
with hole	Order-No. A	628	20930	630	20932	638	20940	636	20938	600	20902		
	Price	€ 5,10	€ 6,10	€ 5,10	€ 6,10	€ 5,10	€ 6,10	€ 5,10	€ 6,10	€ 4,80	€ 6,10		

27 Series

Scale 1:2

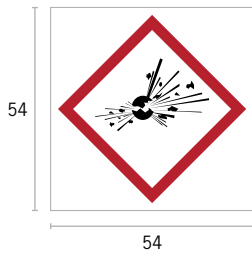
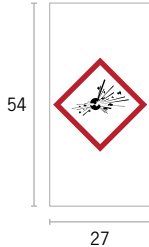

Scale 1:1

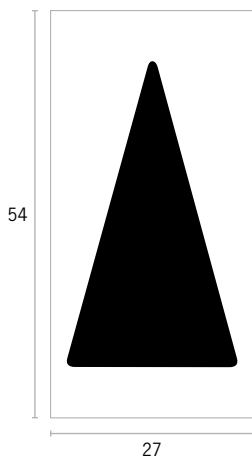

Gs GHS pictograms

Material	Quantity	Article
Luxotherm® L / Aluminium, anodised A	10 pieces	0009

	Mat.	GHS 01		GHS 02		GHS 03		GHS 04		GHS 05	
		27 mm	54 mm	27 mm	54 mm	27 mm	54 mm	27 mm	54 mm	27 mm	54 mm
Order-No.	L	463	33333	466	33334	469	33335	471	33336	474	33337
Price	L	€ 3,35	€ 5,65	€ 3,35	€ 5,65	€ 3,35	€ 5,65	€ 3,35	€ 5,65	€ 3,35	€ 5,65
Order-No.	A	438	33324	441	33325	444	33326	446	33327	449	33328
Price	A	€ 6,30	€ 10,50	€ 6,30	€ 10,50	€ 6,30	€ 10,50	€ 6,30	€ 10,50	€ 6,30	€ 10,50

	Mat.	GHS 06		GHS 07		GHS 08		GHS 09	
		27 mm	54 mm	27 mm	54 mm	27 mm	54 mm	27 mm	54 mm
Order-No.	L	476	33341	478	33338	481	33339	483	33340
Price	L	€ 3,35	€ 5,65	€ 3,35	€ 5,65	€ 3,35	€ 5,65	€ 3,35	€ 5,65
Order-No.	A	451	33329	453	33330	456	33331	458	33332
Price	A	€ 6,30	€ 10,50	€ 6,30	€ 10,50	€ 6,30	€ 10,50	€ 6,30	€ 10,50

Af Flow direction arrows

Material	Quantity	Article
Luxotherm® L / Aluminium, anodised A	10 pieces	0009

	Mat.	Arrow 1		Arrow 2		Arrow 3	
		27 mm	54 mm	27 mm	54 mm	27 mm	54 mm
Order-No.	L	484	485	30307	30308		
Price	L	€ 2,60	€ 2,60	€ 2,60	€ 2,60		
Order-No.	A	459	460	30305	30306		
Price	A	€ 5,20	€ 5,20	€ 5,20	€ 5,20		

27 Series



Gs GHS double pictograms

Material	Quantity	Article
Luxotherm® L / Aluminium, anodised A	10 pieces	0009

GHS 01/02	GHS 01/05	GHS 01/06	GHS 01/07	GHS 01/08	GHS 01/09

<i>Mat.</i>						
Order-No. L	36599	36600	36601	36602	36603	36604
Price	€ 3,35	€ 3,35	€ 3,35	€ 3,35	€ 3,35	€ 3,35
Order-No. A	36574	36575	36576	36577	36578	36579
Price	€ 6,30	€ 6,30	€ 6,30	€ 6,30	€ 6,30	€ 6,30

GHS 02/05	GHS 02/06	GHS 02/07	GHS 02/08	GHS 02/09

<i>Mat.</i>					
Order-No. L	36605	36606	36607	36608	36609
Price	€ 3,35	€ 3,35	€ 3,35	€ 3,35	€ 3,35
Order-No. A	36580	36581	36582	36583	36584
Price	€ 6,30	€ 6,30	€ 6,30	€ 6,30	€ 6,30

GHS 03/05	GHS 03/06	GHS 03/07	GHS 03/08	GHS 03/09

<i>Mat.</i>					
Order-No. L	36610	36611	36612	36613	36614
Price	€ 3,35	€ 3,35	€ 3,35	€ 3,35	€ 3,35
Order-No. A	36585	36586	36587	36588	36589
Price	€ 6,30	€ 6,30	€ 6,30	€ 6,30	€ 6,30

GHS 05/06	GHS 05/07	GHS 05/08	GHS 05/09

<i>Mat.</i>				
Order-No. L	36615	36616	36617	36618
Price	€ 3,35	€ 3,35	€ 3,35	€ 3,35
Order-No. A	36590	36591	36592	36593
Price	€ 6,30	€ 6,30	€ 6,30	€ 6,30

GHS 06/08	GHS 06/09	GHS 07/08	GHS 07/09	GHS 08/09

<i>Mat.</i>					
Order-No. L	36619	36620	36621	36622	36623
Price	€ 3,35	€ 3,35	€ 3,35	€ 3,35	€ 3,35
Order-No. A	36594	36595	36596	36597	36598
Price	€ 6,30	€ 6,30	€ 6,30	€ 6,30	€ 6,30

36 Series

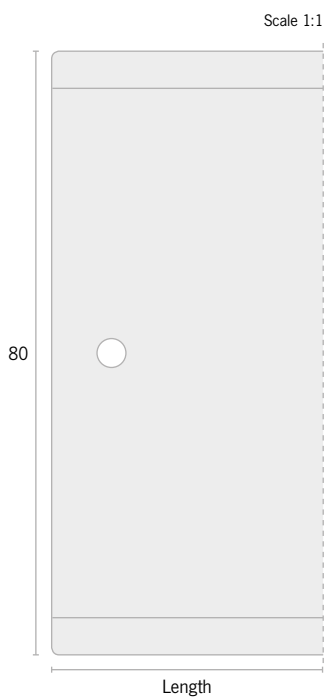
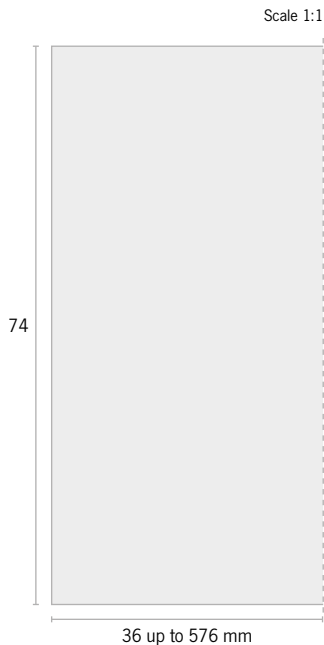

Is Inserts

Standard sizes 36 up to 576 mm. Other sizes and prices on request.

Sp Slide-in profiles

Material		Quantity	Article	
Chlorid free plastic P / Aluminium, anodised A		5 pieces	0008	
Length	Length of insert*	Mat.	Mat.	
108 mm	36 / 72** mm	Order-No. P 6820 Price € 5,05	A 6802 € 7,45	
126 mm	54 / 90** mm	Order-No. P 6821 Price € 5,35	A 6803 € 7,95	
144 mm	72 / 108** mm	Order-No. P 566 Price € 5,65	A 552 € 8,35	
162 mm	90 / 126** mm	Order-No. P 6822 Price € 5,95	A 6804 € 8,75	
180 mm	108 / 144** mm	Order-No. P 567 Price € 6,25	A 553 € 9,15	
198 mm	126 / 162** mm	Order-No. P 6823 Price € 6,55	A 6805 € 9,55	
216 mm	144 / 180** mm	Order-No. P 568 Price € 6,85	A 554 € 9,95	
234 mm	162 / 198** mm	Order-No. P 6825 Price € 7,15	A 6806 € 10,25	
252 mm	180 / 216** mm	Order-No. P 569 Price € 7,45	A 555 € 10,75	
270 mm	198 / 234** mm	Order-No. P 6826 Price € 7,85	A 6807 € 11,15	
288 mm	216 / 252** mm	Order-No. P 570 Price € 8,15	A 556 € 11,55	
306 mm	234 / 270** mm	Order-No. P 6827 Price € 8,45	A 6808 € 11,95	
324 mm	252 / 288** mm	Order-No. P 571 Price € 8,75	A 557 € 12,75	
342 mm	270 / 306** mm	Order-No. P 6828 Price € 9,05	A 6809 € 13,55	
360 mm	288 / 324** mm	Order-No. P 572 Price € 9,35	A 558 € 14,35	
378 mm	306 / 342** mm	Order-No. P 6829 Price € 9,65	A 6810 € 15,15	
396 mm	324 / 360** mm	Order-No. P 573 Price € 9,95	A 559 € 17,10	
432 mm	360 / 396** mm	Order-No. P 574 Price € 10,25	A 560 € 18,70	
468 mm	396 / 432** mm	Order-No. P 575 Price € 10,55	A 561 € 20,30	
486 mm	414 / 450** mm	Order-No. P 6830 Price € 10,85	A 6811 € 21,90	
504 mm	432 / 468** mm	Order-No. P 576 Price € 11,15	A 562 € 23,50	
540 mm	468 / 504** mm	Order-No. P 577 Price € 11,45	A 563 € 25,90	
576 mm	504 / 540** mm	Order-No. P 578 Price € 12,05	A 564 € 28,30	
612 mm	540 / 576** mm	Order-No. P 579 Price € 12,65	A 565 € 30,70	

*The number of symbols takes into account that there are always two additional outer elements.

**With half outer elements

36 Series

Scale 1:1

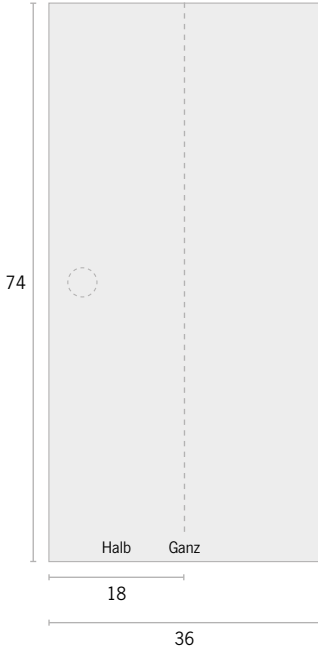

Oe Outer elements

Material		Quantity		Article	
Luxotherm® L / Aluminium, anodised A		10 pieces		0007	
DIN 2403					
No colour		Oxygen		Water	
RAL5005		RAL6032		RAL3001	
RAL7004		Air			
Neutral		Group 0		Group 1	
Group 2		Group 3			
Design	Mat.	Ganz	Halb	Ganz	Halb
without hole	Order-No. L	695	807	679	791
	Price	€ 4,80	€ 5,55	€ 4,80	€ 5,55
with hole	Order-No. A	675	787	659	771
	Price	€ 9,50	€ 11,75	€ 9,50	€ 11,75
Gases					
RAL1003		Acids		Alkalis	
RAL2010		Liquids and fixed materials		Other colours	
RAL4008		RAL8002		Black	
Group 4/5		Group 6		Group 7	
Group 8/9		Zusatz			
Design	Mat.	Ganz	Halb	Ganz	Halb
without hole	Order-No. L	687	799	689	801
	Price	€ 4,80	€ 5,55	€ 4,80	€ 5,55
with hole	Order-No. A	667	779	669	781
	Price	€ 9,50	€ 11,75	€ 9,50	€ 11,75
NEN 3050					
No colour		Steam		Fire fighting	
RAL9006		RAL3000		Gases and liquid gases	
RAL1004		RAL4001			
Design	Mat.	Ganz	Halb	Ganz	Halb
without hole	Order-No. L	695	807	729	765
	Price	€ 4,80	€ 5,55	€ 4,80	€ 5,55
with hole	Order-No. A	675	787	711	747
	Price	€ 9,50	€ 11,75	€ 9,50	€ 11,75
Air					
RAL5012		Oils and flammable liquids		Acids	
RAL8001		Water		Other liquids	
RAL2008		RAL6010		Black	
Design	Mat.	Ganz	Halb	Ganz	Halb
without hole	Order-No. L	723	759	725	761
	Price	€ 4,80	€ 5,55	€ 4,80	€ 5,55
with hole	Order-No. A	705	741	707	743
	Price	€ 9,50	€ 11,75	€ 9,50	€ 11,75

Scale 1:1

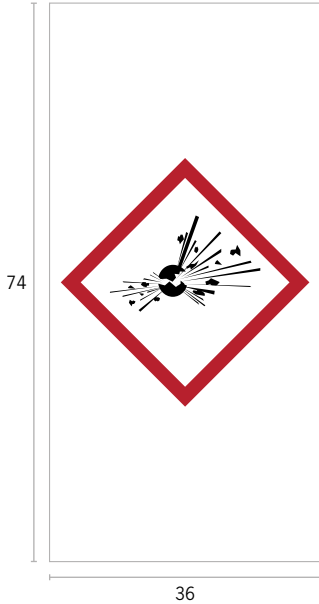

Gs GHS pictograms

Material	Quantity	Article
Luxotherm® L / Aluminium, anodised A	10 pieces	0009

	Mat.	GHS 01		GHS 02		GHS 03		GHS 04		GHS 05	
		36 mm	72 mm	36 mm	72 mm	36 mm	72 mm	36 mm	72 mm	36 mm	72 mm
Order-No.	L	513	33351	516	33352	519	33353	521	33354	524	33355
Price		€ 6,00	€ 10,40	€ 6,00	€ 10,40	€ 6,00	€ 10,40	€ 6,00	€ 10,40	€ 6,00	€ 10,40
Order-No.	A	488	33342	491	33343	494	33344	496	33345	499	33346
Price		€ 11,80	€ 21,20	€ 11,80	€ 21,20	€ 11,80	€ 21,20	€ 11,80	€ 21,20	€ 11,80	€ 21,20

	Mat.	GHS 06		GHS 07		GHS 08		GHS 09	
		36 mm	72 mm	36 mm	72 mm	36 mm	72 mm	36 mm	72 mm
Order-No.	L	526	33356	528	33357	531	33358	533	33359
Price		€ 6,00	€ 10,40	€ 6,00	€ 10,40	€ 6,00	€ 10,40	€ 6,00	€ 10,40
Order-No.	A	501	33347	503	33348	506	33349	508	33350
Price		€ 11,80	€ 21,20	€ 11,80	€ 21,20	€ 11,80	€ 21,20	€ 11,80	€ 21,20

Scale 1:1

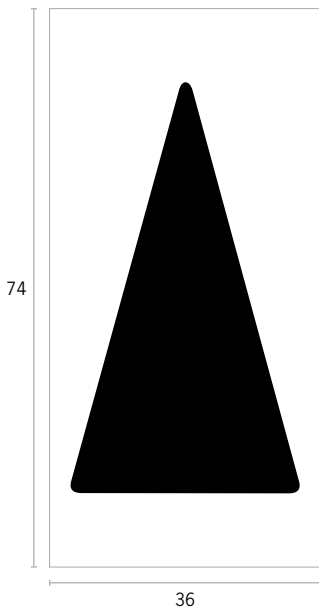

Af Flow direction arrows

Material	Quantity	Article
Luxotherm® L / Aluminium, anodised A	10 pieces	0009

	Mat.	Flow direction arrow 1		Flow direction arrow 2		Flow direction arrow 3		Flow direction arrow 4	
		36 mm	72 mm	36 mm	72 mm	36 mm	72 mm	36 mm	72 mm
Order-No.	L	534		535		30311		30312	
Price		€ 4,90		€ 4,90		€ 4,90		€ 4,90	
Order-No.	A	509		510		30309		30310	
Price		€ 9,60		€ 9,60		€ 9,60		€ 9,60	

Pipe Labelling – Stickers and Tapes



Proper pipe identification not only poses fewer potential risks for your employees, but it also facilitates repair and maintenance work in industrial plants and power stations. At the very least, and in accordance with the German regulation TRGS 201 (“Technical Rules for Hazardous Substances” 201), pipes must be labelled with the fluid conveyed and the flow direction. With our product range and know-how, we also provide our customers with the certainty that their labelling meets the requirements of DIN 2403.

Product overview:

- **Pipe markers** – cost-effective solution for pipes with a small labelling area
- **Colour tape** – individually labelling of pipes according to the fluid conveyed
- **Arrow tape** – individually labelling of pipes according to the flow direction
- **Text tape** – readable from all sides because they are completely wrapped around the pipe
- **GHS tape** – for labelling hazardous substances in accordance with the GHS regulation

Specifics of our Pipe Markers and Tapes:

- Flame-resistant
- Self-extinguishing
- Extreme adhesive power
- Mostly resistant against acid and alkaline substances
- UV resistant
- Can be applied at temperatures of 5°C to 45°C
- Resistant to temperatures of –20°C to –110°C
- Mostly solvent resistant
- Weatherproof

You can of course also label your pipes with the array of products from the slide-in system or printed and engraved signs. Contact us – we will gladly find the best solution for you.



Pipe markers

Material	Temperature resistance	Quantity
Foil	-20 – 110°C	1 piece

DIN 2403

Application	Colour	Additional colour	Text colour
Oxygen	RAL5005	-	RAL9003 (white)
Water	RAL6032	-	RAL9003 (white)
Steam	RAL3001	-	RAL9003 (white)
Air	RAL7004	-	RAL9004
Flammable gases	RAL1003	RAL3001	RAL9004
Non flammable gases	RAL1003	RAL9004	RAL9004
Acids	RAL2010	-	RAL9004
Alkalis	RAL4008	-	RAL9003 (white)
Flammable liquids and fixed materials	RAL8002	RAL3001	RAL9003 (white)
Non flammable liquids and fixed materials	RAL8002	RAL9004	RAL9003 (white)

NEN 3050

Application	Colour
Alkalis	RAL4001
Fire fighting	RAL3000
Gases and liquid gases	RAL1004
Air	RAL5012
Oils and flammable liquids	RAL8001
Other liquids	RAL9004
Steam	RAL9006
Water	RAL6010
Acids (based on a recommendation of NWS)	RAL2008

Distance of observation

The formula for calculating the distance of observation is:

$$D = h \times Z$$

D = distance of observation in m,
 h = font height in mm,
 Z = distance factor:
 300 for letters and symbols
 40 for safety symbols

Dimensions and distance of observation



Width x Height (mm)	110 x 18	156 x 25	227 x 37	402 x 52	450 x 73	720 x 116
Font height (mm)	12	17	25	29	50	80
Distance of observation (m)	3,6	5,1	7,5	8,7	15	24

Pm Pipe markers

GHS tapes **Gt**

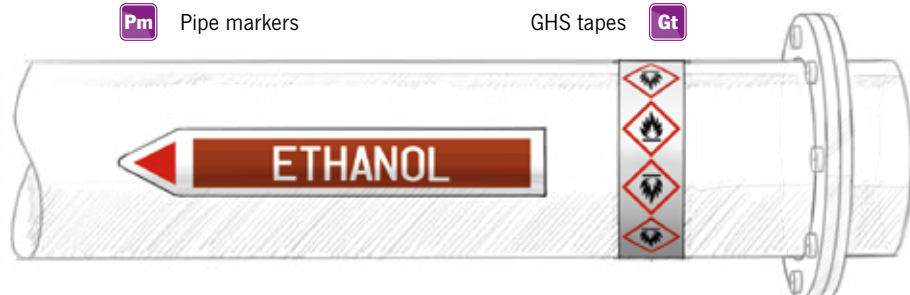



Colour tapes

Material	Temperature resistance	Quantity	Article
Foil	-20 – 110°C	1 piece	0004

DIN 2403

Width x Length	Application	Colour	Quantity		
			W = 35 mm	W = 75 mm	W = 150 mm
W x 25 Meter	Sauerstoff	RAL5005	Order-No. 903 Price € 42,00	915 € 79,00	927 € 140,00
W x 25 Meter	Wasser	RAL6032	Order-No. 904 Price € 42,00	916 € 79,00	928 € 140,00
W x 25 Meter	Wasserdampf	RAL3001	Order-No. 905 Price € 42,00	917 € 79,00	929 € 140,00
W x 25 Meter	Luft	RAL7004	Order-No. 906 Price € 42,00	918 € 79,00	930 € 140,00
W x 25 Meter	Gase	RAL1003	Order-No. 907 Price € 42,00	919 € 79,00	931 € 140,00
W x 25 Meter	Säuren	RAL2010	Order-No. 908 Price € 42,00	920 € 79,00	932 € 140,00
W x 25 Meter	Laugen	RAL4008	Order-No. 909 Price € 42,00	921 € 79,00	933 € 140,00
W x 25 Meter	Flüssigkeiten u. Feststoffe	RAL8002	Order-No. 910 Price € 42,00	922 € 79,00	934 € 140,00
W x 25 Meter	Feuerlöscheinrichtung wasserführend	RAL3001 RAL6032	Order-No. 911 Price € 42,00	923 € 79,00	935 € 140,00
W x 25 Meter	Feuerlöscheinrichtung gasführend	RAL3001 RAL1003	Order-No. 912 Price € 42,00	924 € 79,00	936 € 140,00
W x 25 Meter	Feuerlöscheinrichtung dampfführend	RAL3001 RAL3001	Order-No. 913 Price € 42,00	925 € 79,00	937 € 140,00
W x 25 Meter	Feuerlöscheinrichtung sonstige	RAL3001 RAL9004	Order-No. 914 Price € 42,00	926 € 79,00	938 € 140,00

NEN 3050

Width x Length	Application	Colour	Quantity		
			W = 35 mm	W = 75 mm	W = 150 mm
W x 25 Meter	Laugen und Basen	RAL4001	Order-No. 939 Price € 42,00	948 € 79,00	957 € 140,00
W x 25 Meter	Feuerlöschmedien	RAL3000	Order-No. 940 Price € 42,00	949 € 79,00	958 € 140,00
W x 25 Meter	Gase und flüssige Gase	RAL1004	Order-No. 941 Price € 42,00	950 € 79,00	959 € 140,00
W x 25 Meter	Luft und Vakuum	RAL5012	Order-No. 942 Price € 42,00	951 € 79,00	960 € 140,00
W x 25 Meter	Öle und brennbare Flüssigkeiten	RAL8001	Order-No. 943 Price € 42,00	952 € 79,00	961 € 140,00
W x 25 Meter	Andere Flüssigkeiten	RAL9004	Order-No. 944 Price € 42,00	953 € 79,00	962 € 140,00
W x 25 Meter	Dampf	RAL9006	Order-No. 945 Price € 42,00	954 € 79,00	963 € 140,00
W x 25 Meter	Wasser	RAL6010	Order-No. 946 Price € 42,00	955 € 79,00	964 € 140,00
W x 25 Meter	Säuren (nach Empfehlung der NWS)	RAL2008	Order-No. 947 Price € 42,00	956 € 79,00	965 € 140,00

Ct Colour tapes





Arrow tapes

Material	Temperature resistance	Quantity	Article
Foil	-20 – 110°C	1 piece	0006

DIN 2403

Width x Length	Application	Bandfarbe	Pfeilfarbe	Order-No.	W = 35 mm	W = 75 mm	W = 150 mm
W x 25 Meter	Sauerstoff	RAL5005		811 Price € 42,00	831 € 79,00	851 € 140,00	
W x 25 Meter	Wasser	RAL6032		812 € 42,00	832 € 79,00	852 € 140,00	
W x 25 Meter	Wasserdampf	RAL3001		813 € 42,00	833 € 79,00	853 € 140,00	
W x 25 Meter	Luft	RAL7004		814 € 42,00	834 € 79,00	854 € 140,00	
W x 25 Meter	brennbare Gase	RAL1003		815 € 42,00	835 € 79,00	855 € 140,00	
W x 25 Meter	nicht brennbare Gase	RAL1003		816 € 42,00	836 € 79,00	856 € 140,00	
W x 25 Meter	Säuren	RAL2010		817 € 42,00	837 € 79,00	857 € 140,00	
W x 25 Meter	Laugen	RAL4008		818 € 42,00	838 € 79,00	858 € 140,00	
W x 25 Meter	Brennbare Flüssigkeiten/Feststoffe	RAL8002		819 € 42,00	839 € 79,00	859 € 140,00	
W x 25 Meter	Nicht brennbare Flüssigkeiten/Feststoffe	RAL8002		820 € 42,00	840 € 79,00	860 € 140,00	
W x 25 Meter	Richtungsangabe	No colour		821 € 42,00	841 € 79,00	861 € 140,00	
W x 25 Meter	Richtungsangabe	No colour		35281 € 42,00	35282 € 79,00	35283 € 140,00	

NEN 3050

Width x Length	Application	Wandfarbe	Pfeilfarbe	Order-No.	W = 35 mm	W = 75 mm	W = 150 mm
W x 25 Meter	Laugen und Wasen	RAL4001		822 € 42,00	842 € 79,00	862 € 140,00	
W x 25 Meter	Feuerlöschmedien	RAL3000		823 € 42,00	843 € 79,00	863 € 140,00	
W x 25 Meter	Gase und flüssige Gase	RAL1004		824 € 42,00	844 € 79,00	864 € 140,00	
W x 25 Meter	Luft und Vakuum	RAL5012		825 € 42,00	845 € 79,00	865 € 140,00	
W x 25 Meter	Öle und brennbare Flüssigkeiten	RAL8001		826 € 42,00	846 € 79,00	866 € 140,00	
W x 25 Meter	Andere Flüssigkeiten	RAL9004		827 € 42,00	847 € 79,00	867 € 140,00	
W x 25 Meter	Dampf	RAL9006		828 € 42,00	848 € 79,00	868 € 140,00	
W x 25 Meter	Wasser	RAL6010		829 € 42,00	849 € 79,00	869 € 140,00	
W x 25 Meter	Säuren (nach Empfehlung der NWS)	RAL2008		830 € 42,00	850 € 79,00	870 € 140,00	

At Arrow tapes

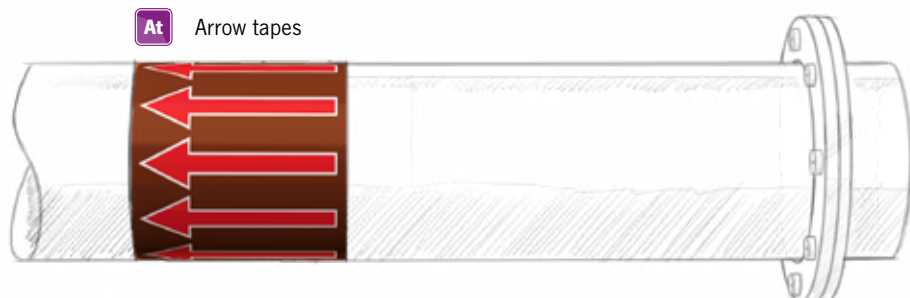



Text tapes

Material	Temperature resistance	Quantity
Foil	-20 – 110°C	1 piece

DIN 2403

Width x Length	Application	Colour	W = 35 mm	W = 75 mm	W = 150 mm
W x 25 Meter	Oxygen	RAL5005	All prices on request	All prices on request	All prices on request
W x 25 Meter	Water	RAL6032			
W x 25 Meter	Steam	RAL3001			
W x 25 Meter	Air	RAL7004			
W x 25 Meter	Flammable gases	RAL1003			
W x 25 Meter	Non flammable gases	RAL1003			
W x 25 Meter	Acids	RAL2010			
W x 25 Meter	Alkalis	RAL4008			
W x 25 Meter	Flammable liquids and fixed materials	RAL8002			
W x 25 Meter	Non flammable liquids and fixed materials	RAL8002			
W x 25 Meter	Direction	No colour			

NEN 3050







Width x Length	Application	Colour	W = 35 mm	W = 75 mm	W = 150 mm
W x 25 Meter	Alkalis	RAL4001	All prices on request	All prices on request	All prices on request
W x 25 Meter	Fire fighting	RAL3000			
W x 25 Meter	Gases and liquid gases	RAL1004			
W x 25 Meter	Air	RAL5012			
W x 25 Meter	Oils and flammable liquids	RAL8001			
W x 25 Meter	Other liquids	RAL9004			
W x 25 Meter	Steam	RAL9006			
W x 25 Meter	Water	RAL6010			
W x 25 Meter	Acids (recommendation of NWS)	RAL2008			







GHS tapes

Material	Temperature resistance	Quantity	Article
Foil	-20 – 110°C	1 piece	0005

Width x Length						
	GHS 01	GHS 02	GHS 03	GHS 04	GHS 05	GHS 06
35 mm x 25 Meter	Order-No. 871 Price € 42,00	Order-No. 872 Price € 42,00	Order-No. 873 Price € 42,00	Order-No. 874 Price € 42,00	Order-No. 875 Price € 42,00	Order-No. 876 Price € 42,00
75 mm x 25 Meter	Order-No. 882 Price € 79,00	Order-No. 885 Price € 79,00	Order-No. 888 Price € 79,00	Order-No. 890 Price € 79,00	Order-No. 893 Price € 79,00	Order-No. 895 Price € 79,00
150 mm x 25 Meter	Order-No. 33272 Price € 140,00	Order-No. 33273 Price € 140,00	Order-No. 33274 Price € 140,00	Order-No. 33275 Price € 140,00	Order-No. 33276 Price € 140,00	Order-No. 33277 Price € 140,00

Width x Length			
	GHS 07	GHS 08	GHS 09
35 mm x 25 Meter	Order-No. 877 Price € 42,00	Order-No. 878 Price € 42,00	Order-No. 879 Price € 42,00
75 mm x 25 Meter	Order-No. 897 Price € 79,00	Order-No. 900 Price € 79,00	Order-No. 902 Price € 79,00
150 mm x 25 Meter	Order-No. 33278 Price € 140,00	Order-No. 33279 Price € 140,00	Order-No. 33280 Price € 140,00

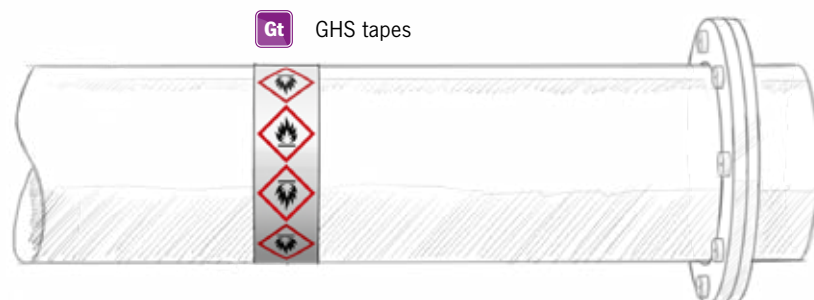

Gt GHS tapes



Module system and adhesive film stickers

Our module system allows for flexible combinations of all pipe labelling stickers and tapes. You can combine different pipe labelling variants (colour, arrow and GHS tapes) and complement with an adhesive film sticker. The size of this, sticker showing the actual name of the substance within the pipe, can be adjusted individually. The height of the font is determined according to available place and diameter of the pipe and requested distance of observation in order to ensure the readability of the information even from great distance.



Tank Labelling



Tanks containing hazardous substances must be labelled according to German regulation TRGS 201 in order to ensure correct identification of the contents. The information must be mounted in a clearly visible, safe and durable manner. On the one hand, this aids in the work of your responsible employees, and on the other, easy-to-read and quickly comprehensible labels facilitate the tasks that fire brigades and rescue workers perform in emergency situations.

Using various designs, we adapt the labelling to suit your situation on site. As a rule, flexible basic materials or films are printed in combination with the desired information on the tanks' contents and the necessary hazard indicators. In doing so, the size of the labelling should be adapted not only to the on-site conditions and installation location, but also to the bend in the base area and the desired observations distance. In Germany, it is mandatory to label and tanks with

GHS pictograms. In addition, some tanks are furnished with hazardous diamonds or safety and identification numbers according to their hazard class, displaying the relevant hazards. Furthermore, information about volume, inner pressure or a numeric order might be required. We are prepared to address your individual needs regarding contents, manufacturing and fastening.



NFPA 704 Hazard Diamond

Standard System for the Identification of the Hazard of Materials for Emergency Response

In case of accidents involving hazardous substances, the hazard diamond helps safety and rescue forces to immediately evaluate possible dangers. The hazard diamond shows four coloured fields: blue for safety hazards, red for flammability, yellow for instable substances and a white field at the bottom for specific warning information.

Health Hazard

0	Poses no health hazard
1	Minor hazard breathing apparatus recommended
2	Dangerous Wear light protective clothing and breathing apparatus in danger zone
3	Very dangerous Wear full protective clothing and breathing apparatus in danger zone
4	Can be lethal Avoid any contact with vapours or liquids without suitable protective equipment

Flammability

0	Materials will not burn under typical conditions
1	Materials require considerable preheating before ignition / combustion can occur
2	Materials must be moderately heated before ignition can occur
3	Materials can be ignited under almost all ambient temperature
4	Materials will burn readily at normal temperatures

Instability

0	Normally stable
1	Can become unstable at elevated temperatures Protection measures required
2	Violent chemical reaction possible; advanced protection measures required; execute fire-fighting only from safe distance
3	Capable of detonation or explosive decomposition when heated or severely shocked; establish a safety zone; execute fire-fighting only from safe distance
4	Readily capable of detonation or explosive decomposition; establish a safety zone; evacuate area in case of fire

(empty)	Use water as extinguishing agent
W	Do not use water as extinguishing agent
OX	Oxidizer, chemicals burn without air supply
ACID	Strong acid
ALK	Strong base
COR	Strong corrosive
BIO	Biological hazard
☢	Radioactive hazard

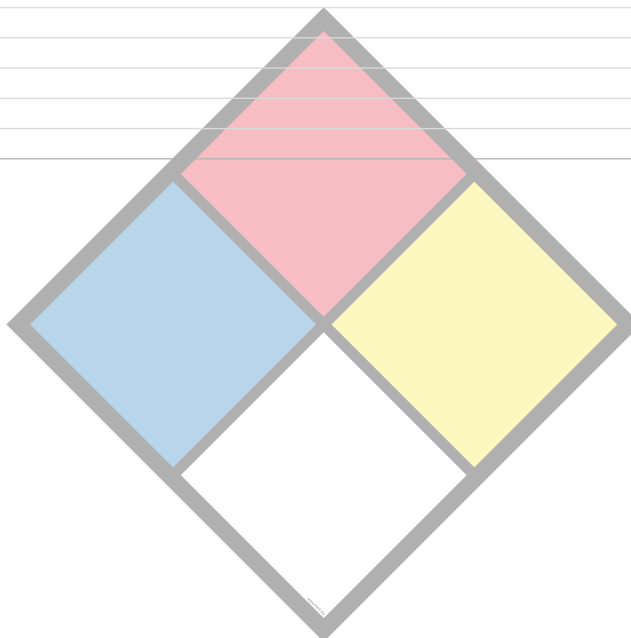

400

T-501
13150m³
METHANOL

2000

700

T866
ALLYLCHLORID

2000

850

V2502a
H2S 20m³
HYDROGEN SULPHIDE

1500



Pre-labelling

Pre-labelling tags make things easier for both you and us. They are installed as temporary labels in the plant during construction and renovation works and are then replaced by the significantly more durable and uniformly recognisable plant labelling upon the launch of plant operations or thereafter. For this temporary application, we offer you a good price-performance ratio with regard to durability, ease of use and cost.



Pre-labelling tags

Material		Quantity	Article
Plastic P / Painted sheet steel S		100 pieces	0010
Width x Height x Thickness	Colour	Mat.	Mat.
120 x 65 x 0,03 mm	White	Order-No. P 271 Price € 16,10	S 277 € 27,60
120 x 65 x 0,03 mm	Red	Order-No. P 272 Price € 16,10	S 278 € 27,60
120 x 65 x 0,03 mm	Yellow	Order-No. P 273 Price € 16,10	S 279 € 27,60
120 x 65 x 0,03 mm	Green	Order-No. P 274 Price € 16,10	S 280 € 27,60
120 x 65 x 0,03 mm	Blue	Order-No. P 275 Price € 16,10	S - -
120 x 65 x 0,03 mm	Orange	Order-No. P 276 Price € 16,10	S - -



Plomben

Material	Quantity	Article
Lead	1 piece	0019
Application		
For sealing wire	Order-No. 14505 Price € 0,30	



Sealing wire

Material		Quantity	Article
Galvanised steel S / Stainless steel S		100 pieces	0020
Length	Application	Mat.	Mat.
230 mm	Pre-labelling tags	Order-No. S 101 Price € 4,20	S 100 € 18,90

Fastening and Accessories

In order for a sign to aid in providing comprehension, safety and orientation, it must be properly installed. Our fastening products therefore offer the right solution for each of our plant labelling systems. Tried, tested and durable, the different sizes and types of signs can be fastened to the necessary installation points in a clearly visible manner.

Our sign-bracket, which comes in various designs, serves as the base. It matches the sizes and perforations of our original Stell "Stecksystem", the slide-in system and the standardised dimensions of the engraved and printed signs. The sign-bracket is fixed with our pipe clamp, which allows for reliable labelling that is gentle on the object to which it is attached. Our range is broadened by additional fastenings and fastening accessories. For further questions regarding our products our sales team is always at your disposal.



Sb Sign brackets

Material	Quantity	Article
Aluminium AlMg 3 A / Stainless steel S	1 piece	0015

Height	Length	Order-No.	Price	Mat.	Order-No.	Price	Mat.
18 mm	52 mm	A 19924	€ 1,30	S 19895	€ 1,80		
	70 mm	A 181	€ 1,35	S 197	€ 1,85		
	88 mm	A 182	€ 1,40	S 198	€ 1,90		
	106 mm	A 183	€ 1,45	S 199	€ 1,95		
	124 mm	A 184	€ 1,50	S 200	€ 2,00		
	142 mm	A 185	€ 1,55	S 201	€ 2,05		
	160 mm	A 186	€ 1,60	S 202	€ 2,10		
	178 mm	A 123	€ 2,40	S 152	€ 2,70		
	196 mm	A 124	€ 2,50	S 153	€ 2,80		
	214 mm	A 125	€ 2,60	S 154	€ 2,90		
	232 mm	A 126	€ 2,70	S 155	€ 3,00		
	250 mm	A 127	€ 2,80	S 156	€ 3,10		
268 mm	A 128	€ 2,90	S 157	€ 3,30			

Height	Length	Order-No.	Price	Mat.	Order-No.	Price	Mat.
29 mm	52 mm	A 21371	€ 1,30	S 20418	€ 1,90		
	70 mm	A 187	€ 1,40	S 203	€ 1,95		
	88 mm	A 188	€ 1,45	S 204	€ 2,00		
	106 mm	A 189	€ 1,50	S 205	€ 2,05		
	124 mm	A 190	€ 1,55	S 206	€ 2,10		
	142 mm	A 191	€ 1,70	S 207	€ 2,30		
	160 mm	A 192	€ 1,80	S 208	€ 2,40		
	178 mm	A 129	€ 2,50	S 158	€ 3,20		
	196 mm	A 130	€ 2,70	S 159	€ 3,40		
	214 mm	A 131	€ 2,80	S 160	€ 3,50		
	232 mm	A 132	€ 3,00	S 161	€ 3,70		
	250 mm	A 133	€ 3,10	S 162	€ 3,80		
268 mm	A 134	€ 3,30	S 163	€ 4,00			

Height	Length	Order-No.	Price	Mat.	Order-No.	Price	Mat.
40 mm	88 mm	A 135	€ 1,50	S 164	€ 2,10		
	106 mm	A 136	€ 1,60	S 165	€ 2,20		
	124 mm	A 137	€ 1,65	S 166	€ 2,30		
	142 mm	A 138	€ 1,80	S 167	€ 2,40		
	160 mm	A 139	€ 1,90	S 168	€ 2,60		

Height	Length	Order-No.	Price	Mat.	Order-No.	Price	Mat.
49 mm	88 mm	A 6775	€ 1,60	S 6776	€ 2,30		
	106 mm	A 193	€ 1,70	S 209	€ 2,40		
	124 mm	A 194	€ 1,80	S 210	€ 2,50		
	142 mm	A 195	€ 2,00	S 211	€ 2,70		
	160 mm	A 196	€ 2,30	S 212	€ 2,90		
	178 mm	A 146	€ 2,60	S 175	€ 3,50		
	196 mm	A 147	€ 3,00	S 176	€ 3,90		
	214 mm	A 148	€ 3,50	S 177	€ 4,40		
	232 mm	A 149	€ 4,00	S 178	€ 4,90		
	250 mm	A 150	€ 4,60	S 179	€ 5,50		
	268 mm	A 151	€ 5,10	S 180	€ 6,00		



Pc Pipe clamps

Material		Quantity	Article
Stainless steel S		25 pieces	0012

Breite	Spannbereich	Order-No.	Price	Mat.
9 mm	Ø 08 - 12 mm	S 243	€ 24,80	
	Ø 10 - 16 mm	S 244	€ 25,30	
	Ø 12 - 20 mm	S 245	€ 25,90	
	Ø 16 - 25 mm	S 246	€ 27,50	
	Ø 20 - 32 mm	S 247	€ 29,20	
	Ø 25 - 40 mm	S 248	€ 30,80	
	Ø 32 - 50 mm	S 249	€ 32,50	
	Ø 40 - 60 mm	S 250	€ 34,10	
	Ø 50 - 70 mm	S 251	€ 35,80	
	Ø 60 - 80 mm	S 252	€ 37,40	
	Ø 70 - 90 mm	S 253	€ 39,10	
	Ø 80 - 100 mm	S 254	€ 40,70	
	Ø 90 - 110 mm	S 255	€ 42,40	
	Ø 100 - 120 mm	S 256	€ 44,00	
	Ø 110 - 130 mm	S 257	€ 49,50	
	Ø 130 - 150 mm	S 258	€ 57,20	
	Ø 150 - 170 mm	S 259	€ 64,90	
	Ø 170 - 190 mm	S 260	€ 72,60	
	Ø 190 - 210 mm	S 261	€ 80,30	
	Ø 210 - 230 mm	S 262	€ 88,00	
Ø 230 - 250 mm	S 263	€ 96,80		
Ø 250 - 270 mm	S 264	€ 105,60		
Ø 270 - 290 mm	S 32111	€ 114,40		
Ø 290 - 310 mm	S 265	€ 123,20		
Ø 310 - 330 mm	S 32112	€ 132,00		



Cable ties

Material	Quantity	Article
Chlorid free plastic, black	25 pieces	0011
<i>Width x Length</i>		
2,5 x 100 mm	Order-No. Price	266 € 1,40
2,5 x 202 mm	Order-No. Price	267 € 3,50
4,8 x 370 mm	Order-No. Price	33844 € 9,40
9 x 430 mm	Order-No. Price	268 € 16,30
9 x 812 mm	Order-No. Price	269 € 30,10
9 x 1070 mm	Order-No. Price	270 € 42,60



Adhesive foam tape

Material	Quantity	Article
Polyethylene foam	1 piece	0021
<i>Breite</i>		
<i>Application</i>		
<i>Length 10 m</i> <i>Length 50 m</i>		
9 mm, perforated	45 series	Order-No. 89 Price € 14,60
19 mm, perforated	06/09 series	Order-No. 90 Price € 16,20
38 mm	18 series	Order-No. 92 Price € 17,90
58 mm	27 series	Order-No. 6858 Price € 19,50
78 mm	36 series	Order-No. 6859 Price € 24,90



Locks for hanger straps

Material	Quantity	Article
Polyamide P / Stainless steel S	25 pieces	0014
<i>Application</i>		<i>Mat.</i>
For 8 mm smoothed polyamide band	Order-No. Price	P 218 € 8,40
For 7 mm embossed stainless steel band	Order-No. Price	S 213 € 25,90
For 9 mm embossed stainless steel band	Order-No. Price	S 215 € 28,50



Hanger straps

Material		Quantity	Article
Stainless steel S / Polyamide P		1 piece	0013
Width x Length	Design	Order-No.	Price
7 mm x 25 m	Embossed	S 219	€ 38,90
9 mm x 30 m	Embossed	S 221	€ 41,00
8 mm x 50 m	Smooth	P 223	€ 46,00



Steel band, PVC coated

Material		Quantity	Article
Galvanised steel S / Stainless steel S		1 piece	0022
Diameter	Design	1 m	100 m
Ø 2 mm	Steel/plastic	Order-No. 14529 Price € 1,30	87 € 127,50
	Stainless steel/plastic	Order-No. 14531 Price € 1,40	- € 153,90



Seals

Material		Quantity	Article
Aluminium AlMg 3 A / Stainless steel S		1 piece	0019
Application		Order-No.	Price
For coated steel and coated stainless steel band		A 14507	€ 0,10
For ball chains		S 14508	€ 0,30



Br Blind rivets

Material		Quantity	Article
Aluminium A / Plastic P / Stainless steel S		500 pieces	0018
Width x Height	Application	Material sleeve	Material pen
3,0 x 4,5 mm	For bondings	Plastic	Plastic
3,0 x 5,5 mm	For direct riveting	Plastic	Plastic
3,0 x 4,0 mm	For bondings	Aluminium	Stainless steel
3,2 x 7,9 mm	For direct riveting	Aluminium	Stainless steel



Bar holders

Material		Quantity	Article
Aluminium AlMg 3 A / Stainless steel S		10 pieces	0023
Width x Length	Hole	Mat.	Mat.
30 x 110 mm	Ø 8,5 mm	Order-No. A 82 Price € 13,10	Order-No. S 77 Price € 18,50
	Ø 10,5 mm	Order-No. A 83 Price € 13,10	Order-No. S 78 Price € 18,50
	Ø 12,5 mm	Order-No. A 84 Price € 13,10	Order-No. S 79 Price € 18,50
	Ø 16,5 mm	Order-No. A 85 Price € 13,10	Order-No. S 80 Price € 18,50
	Ø 20,5 mm	Order-No. A 86 Price € 13,10	Order-No. S 81 Price € 18,50
30 x 120 mm	Open	Order-No. A 11114 Price € 13,20	Order-No. S 11113 Price € 18,60



Fastening cubes

Material		Quantity	Article
Aluminium A / Stainless steel S		20 pieces	0017
Width x Height x Depth	Application	Mat.	Mat.
15 x 15 x 15 mm	For pipe marking	Order-No. A 117 Price € 14,70	Order-No. S 118 Price € 17,90



Keyrings

Material		Quantity	Article
Steel nickel-plated S / Stainless steel S		1 piece	0104
Diameter		Mat.	Mat.
Ø 20,4 mm		Order-No. S 18525 Price € 0,40	Order-No. S 18524 Price € 0,60



Ball chain

Material		Quantity	Article
Stainless steel S		1 piece	0022
Diameter x Length		Order-No.	Price
Ø 2 mm x 15 cm		S 14526	€ 1,00
Ø 2 mm x 1 m		S 14527	€ 3,80
Ø 2 mm x 50 m		S 14528	€ 135,00



Link chain

Material	Quantity	Article
Steel nickel-plated S / Stainless steel S	1 piece	0022
<i>Diameter x Length</i>		
Ø 8 mm x 1 m		
	<i>Mat.</i>	<i>Mat.</i>
Order-No.	30233	30232
Price	€ 2,60	€ 7,30



Cartridge skeleton gun

	Quantity	Article
	1 piece	0091
<i>Application</i>		
For adhesives and sealants from the cartridge	Order-No.	5456
	Price	€ 13,00



Rivet gun

	Quantity	Article
	1 piece	0091
<i>Application</i>		
For all riveting work	Order-No.	6770
	Price	€ 42,20



Rivet removing gun

	Quantity	Article
	1 piece	0091
<i>Application</i>		
For loosening of riveted joints	Order-No.	5455
	Price	€ 210,60



Tool for tension /cutting

	Quantity	Article
	1 piece	0091
<i>Application</i>		
For processing the polyamide hanger strap	Order-No.	5674
	Price	€ 264,60



Glue

	Quantity	Article
	1 piece	0091
<i>Design</i>		
Cartridge, 310 ml	<i>Application</i>	
	For the assembly of signs, transparent	Order-No.
		Price
		47477
		€ 17,30



Cleaner sprays

	Quantity	Article
	1 piece	0091
<i>Design</i>		
	<i>Application</i>	
Spray can, 500 ml	For degreasing metallic surfaces, glass and ceramics (check suitability before use)	Order-No.
		Price
		33847
		€ 12,50
Spray can, 500 ml	For cleaning heavily soiled surfaces	Order-No.
		Price
		33848
		€ 7,10

Plans for Process Engineering

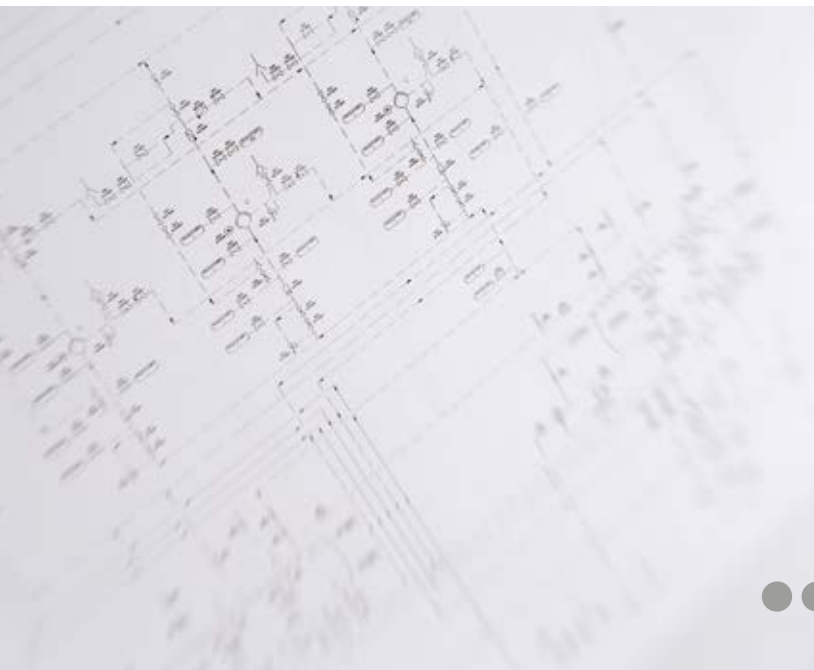

When it comes to plant labelling, our business approach also includes the documentation of our work and your plant. If desired, we can work with our in-house CAD department to prepare your identification System for Power Stations (KKS) according to the latest revision. Complete and current documentation give you the security you need for plant operation. By using a complete historical reproduction of changes in the plant as well as the documentation of the current situation, operational safety can be increased in accident and emergency situations.

Our employees will compare existing P&IDs with the current state (as-built-check) in the plant. This way, missing components can be supplemented, components that have been dismantled (e.g. as a result of renovation) can be removed and missing data can be gathered for your database. The documentation then depicts the actual condition of your plant and, using the revised P&IDs, we can assign both the quantity structures and texts (in coordination with the client) for your labelling. Our highly-qualified CAD department will then deliver the plans to you in file format; the desired attributes and digital information from AutoCAD P&ID are included.

We offer the following services:

- On-site inventory audit (as-built-check) including demand assessment
- P&ID preparation that considers the relevant standards and laws
- Determining quantity structures and batch sizes for the different sign variants
- Preparing specifications for the labelling
- Assigning and coding the equipment according to identification Systems for Power Stations (KKS) and plant labelling systems
- Preparing text and sign lists, including colour coding
- Plotting / printing the plans

In the area of plant labelling, we offer you the following forms of digital plans, among others:

Piping and Instrumentation Diagrams (in accordance with DIN EN ISO 10628)

The Piping and Instrumentation Diagram is used to display a plant's technical equipment. The plans show the structure and function of process plants and are part of the complete technical documentation that is necessary for the planning, construction, on-site installation, administration, commissioning, operation, maintenance and decommissioning of a plant. They also aid in the exchange of information between those involved in the development, construction, on-site installation, operation and maintenance of process plants.

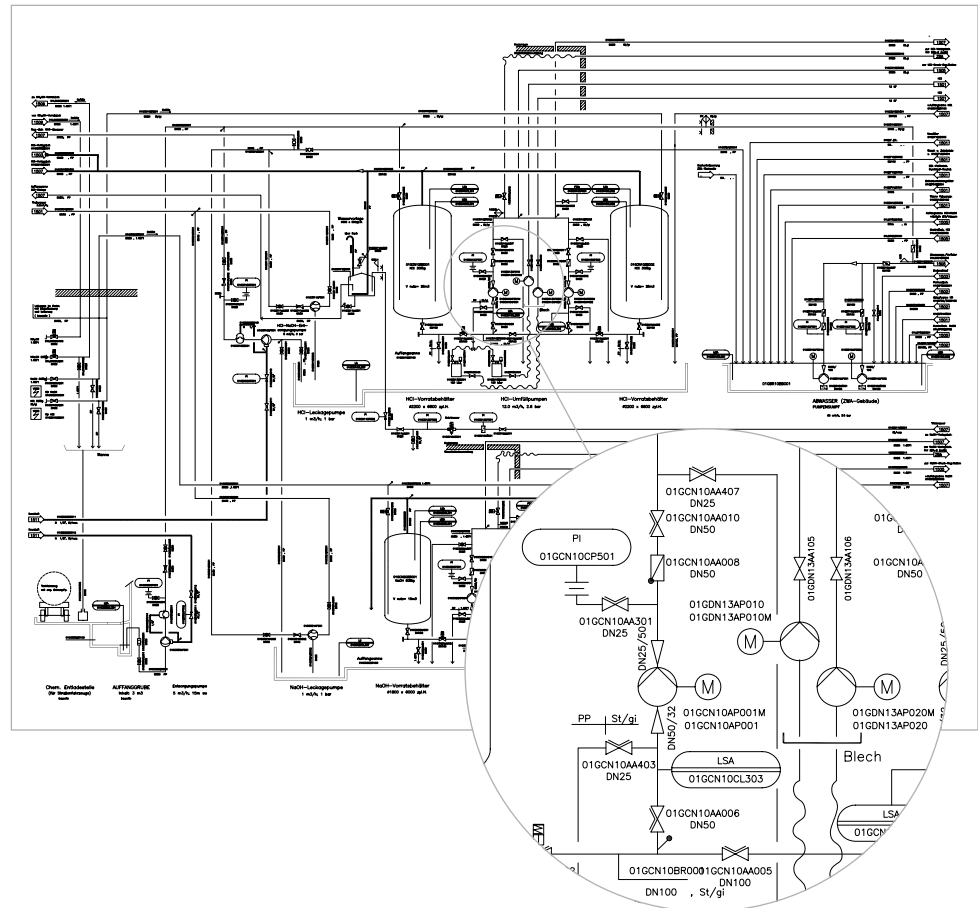

Pipe layout diagram

A pipe layout diagram is a simplified representation of a plant that is not to scale. The diagram mainly marks the vertical pipes and all required safety and control technology fittings, as well as shut-off devices. The pipe layout diagram can serve as the basis for pipe dimensioning. In the planning phase, it can be somewhat of a common thread for the intended material flows.

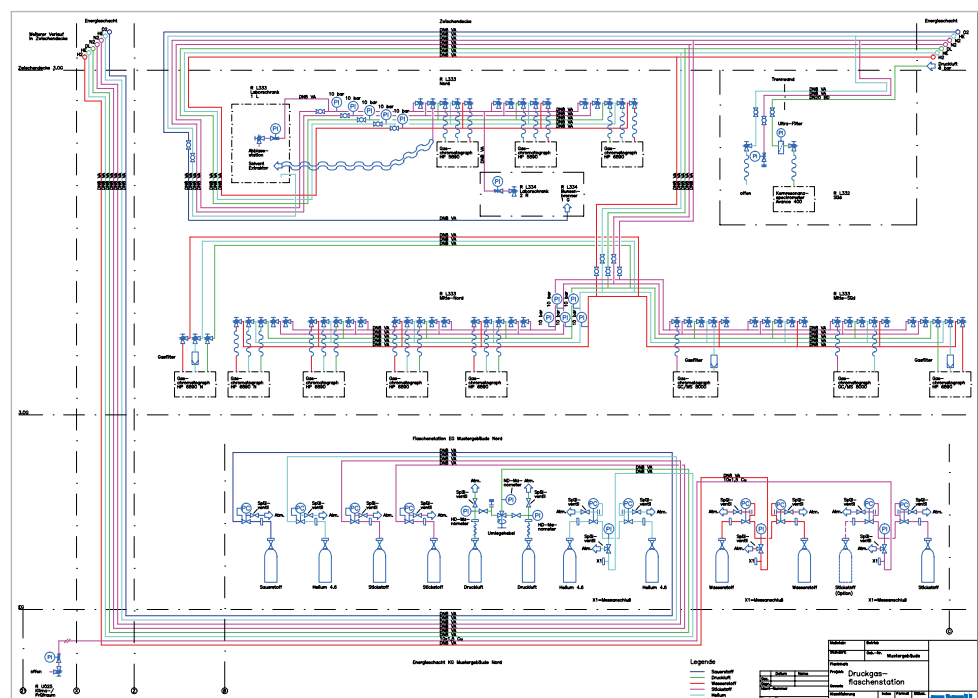

Block diagrams

The diagrams graphically represent the effects between numerous interacting components. A process or process plant is thus depicted in simplified form with the aid of rectangles that are connected by flow lines (e.g., substances, energies, energy carriers).

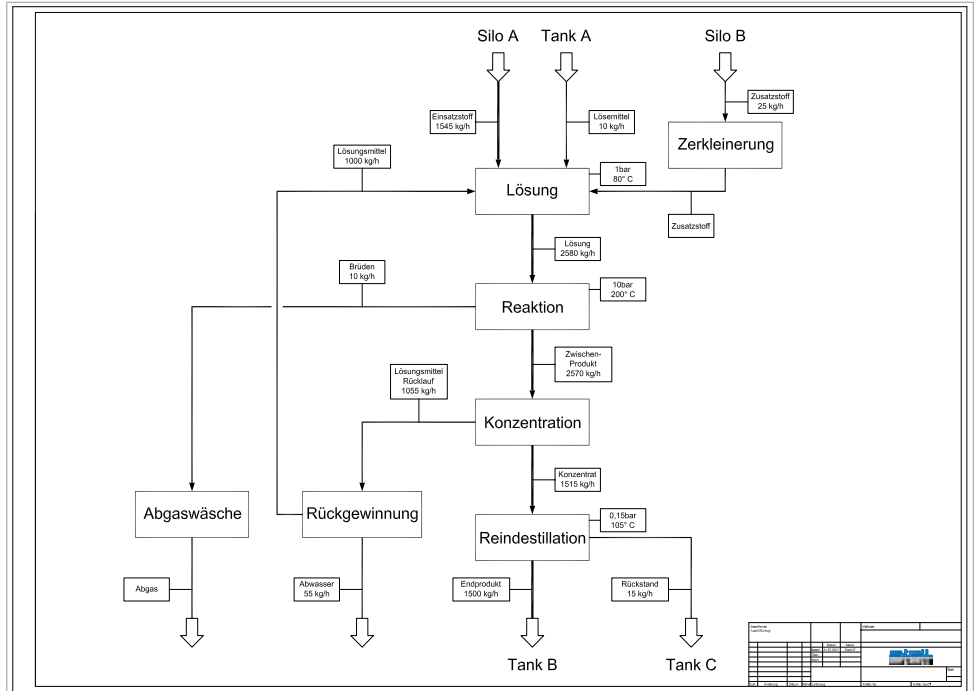

Pipe plans

Technical drawings for the planning and construction of pipes in large chemical industry plants. Pipe plans map the course of pipes and fittings as a top view in existing installation plans.

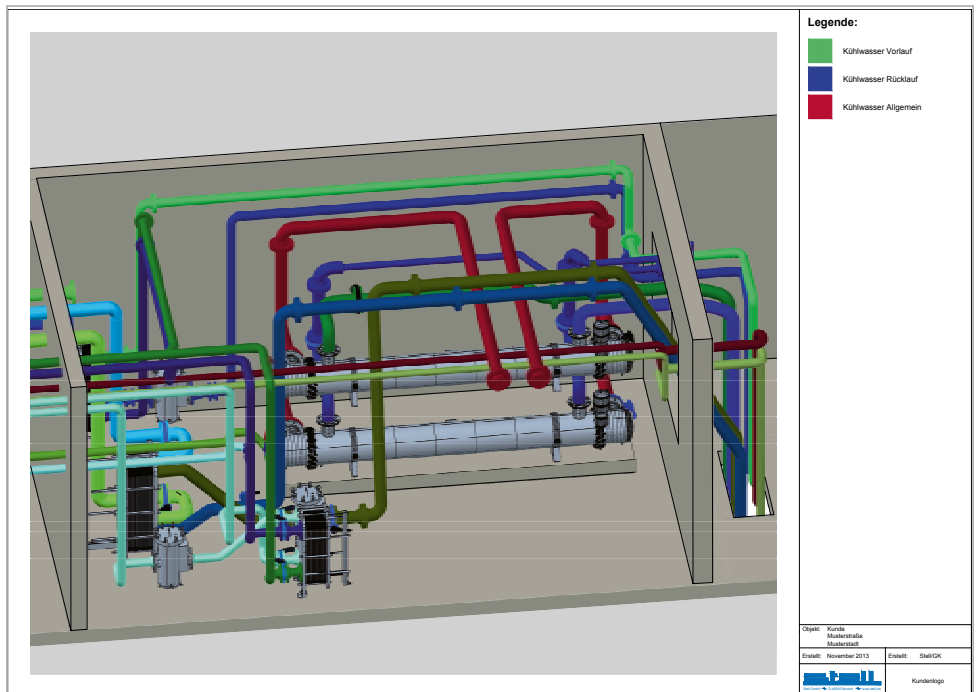

Designs

Upon completion of our work, we give you a data medium that contains the digital documentation of the plans in the desired file format. You of course also have the option to use the printing and plotter service. This includes, amongst others, multi-colour printing, standard formats up to DIN A0, photoluminescent plots, and lamination in various sizes.

Safety Identification



Introduction	76
---------------------	-----------

Safety Way Guidance System	78
-----------------------------------	-----------

End caps, Transparent escape route signs	80
Exit door handle marking, Stairway angles, Floor marking points	81



Safety Signs	82
---------------------	-----------

Escape route signs	83
Escape route, emergency equipment and safety action signs	84
Fire fighting equipment signs	86
Prohibition signs	88
Warning signs	90
Mandatory action signs	92
Floor marking (antislipping)	94



Safety Markings for Obstacles and Hazardous Areas	95
--	-----------

Marking tapes	95
---------------	----



Floor Marking Tapes and Anti-Slip Tapes	96
--	-----------

Floor marking tapes	96
Anti-slip tape, universal	97
Anti-slip tape, easy clean	98
Anti-slip tape, coarse grade	98



Knuffi® Warning and Protection Profiles	99
--	-----------

Corner protection	99
Edge protection, Pipe protection	100
Surface protection	101

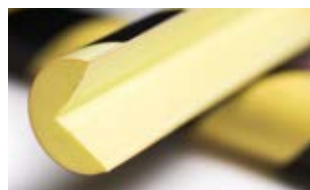

Plans for Safety Identification	102
--	------------

Escape plans	103
Installation plans	104
Fire safety regulation	104
Designs	104



Fastening and Accessories	105
----------------------------------	------------



Introduction



Clear communication regarding hazards and rules of conduct serves as the basis for a safe working environment. Chemical parks, power stations, production plants and business premises must therefore be equipped with systematic labelling for emergency situations and day-to-day operations alike. Safety identification includes labelling of escape routes and fire protection equipment, identifying hazardous areas and how to conduct oneself in them, marking obstacles and potential hazards and putting up escape and rescue plans.

To successfully implement a safe working environment, the right planning, labelling selection and proper on-site installation is key. We offer all of this as a complete package. In our work, we focus on transmitting clear-cut messages. That's why dimensions, shape, colour, design, distance of observation and luminescence of the labels are based on prescribed standards and decades of experience. In collaborating with you, we aim to provide a sustainable solution for reliable safety identification, thus avoiding accidents, injuries and damage. Thanks to our in-house production, we can meet your requirements; what's more is that if you like, we can efficiently carry out (almost) all the relevant work for you on your premises.

Compulsory labelling and its implementation – regulations, standards and laws

Occupational safety identification is globally ubiquitous, compulsory by law, and in Germany derived from the German Arbeitsschutzgesetz ("Occupational Health and Safety Act"). In the Arbeitsstättenverordnung ("Workplaces Ordinance"), labelling with signs is specifically listed as an integral part of the legal measures. The technical rule for workplaces ASR A1.3 – "Safety and health protection labelling" – takes this measure and specifies its exact implementation in detail. This technical rule defines how our signs look in the plant, in the building or on the premises, as well as how to install them to ensure clear recognisability for all employees and visitors.

There are also international regulations and standards for safety identification. The current safety signs in Germany have already been adapted to the international standard ISO 7010. For this reason, we have grouped our signs for you in the following chapter and differentiated between the legally required signs from ASR A1.3 and the meaningful signs of the respective standard. If you would like qualified consultation, please do not hesitate to call us.

Luxolight®

Luxolight® photoluminescent labelling is particularly relevant to safety because even in the event of a power failure or smoke development, it ensures reliable orientation. Luxolight® is a registered trade mark and represents all the photoluminescent products we offer. They meet high quality standards and promote safety in your working environment. Our Luxolight® products absorb the energy of UV rays from ambient light, store it and emit it again in the dark as yellow-green light. Depending on the ambient environment, different afterglow intensities may be necessary; we can provide you with reliable advice here.

As required by workplace regulation ASR A2.3 "Escape routes and emergency exits", all standardised Luxolight® products comply with Class C classification by the manufacturer in accordance with DIN 67510. The following graphics show Luxolight® lighting quality in comparison with the luminance classes and the specifications of workplace regulation ASR A2.3 and ISO 16069.

Luminous qualities of Safety Signs

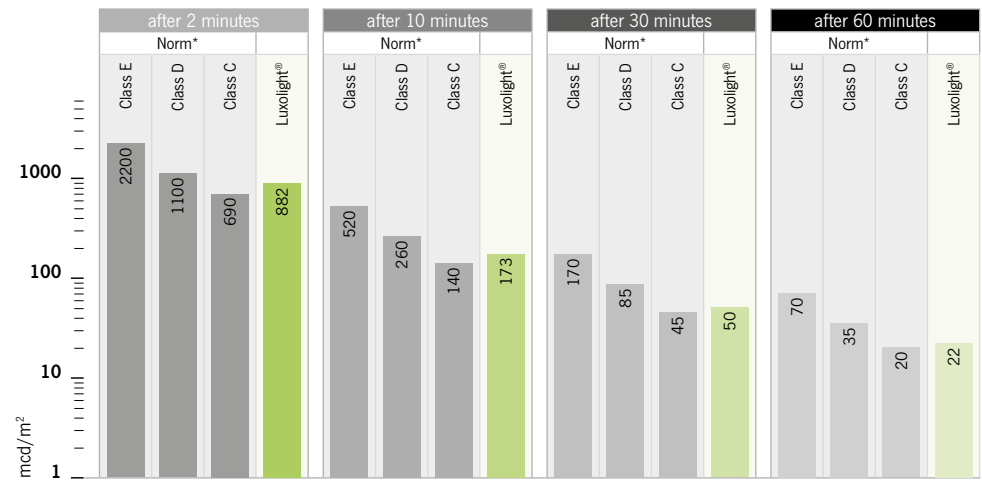

* DIN 67510-1 and ISO 17398

Luminous qualities of Safety Way Guidance Systems

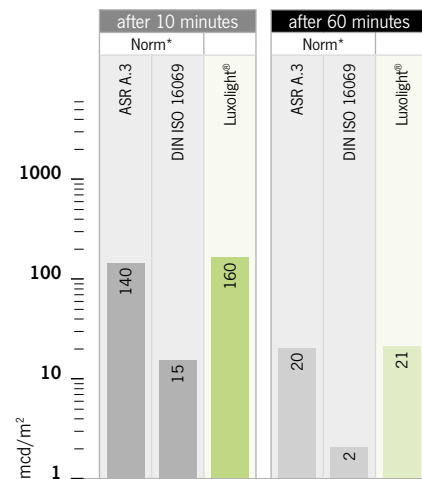

* with 50 mm minimum width

Safety Way Guidance System



An installed safety way guidance system serves as an important protective measure should evacuation be necessary. As part of the safety concept or in consequence of a risk assessment, workplaces and places with increased risk potential must be equipped for emergency with an optical safety way guidance system that directs those affected to a safe environment or meeting points.

A safety way guidance system enables those affected to leave the premises safely and quickly – even in the event of heavy smoke and power failure. For the safety way guidance system we offer different photoluminescence qualities and installation heights that match the

on-site conditions. Thanks to the optical markings and direction indicators, all of these solutions provide for a seamless and reliable escape route. Nevertheless, they are not a substitute for the required rescue symbols that are mounted up above.

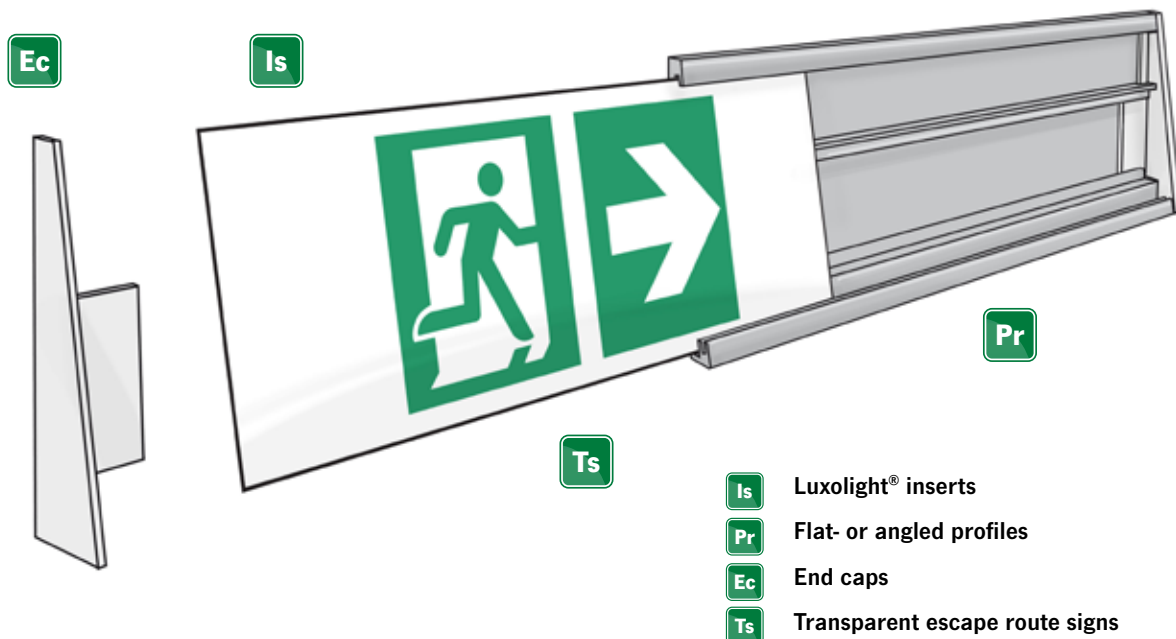

- Is** Luxolight® inserts
- Pr** Flat- or angled profiles
- Ec** End caps
- Ts** Transparent escape route signs

Components of the Safety Way Guidance System

The Safety Way Guidance System consists of the inserts (**Is**), the profile (**Pr**), the transparent safety sign (**Ts**) and end caps (**Ec**). We will gladly assist you determining the right components and materials that suit your demands.

Depending on the on-site conditions, we offer our safety guidance system in two heights, two materials and two design variants.

The angled profile version allows the safety guidance system to be mounted directly over the skirting board. The flat profile is suitable for direct installation on the wall or a surface, even in a slightly higher position.

Both versions are available in heights of 60 mm and 80 mm, whereby the angled profile is only available in aluminum. We offer the flat profile in aluminum and plastic.

As every application is different and customised solutions are the best fit, we produce or slide-in system to your requirements. Please contact us and we will find a suitable solution.

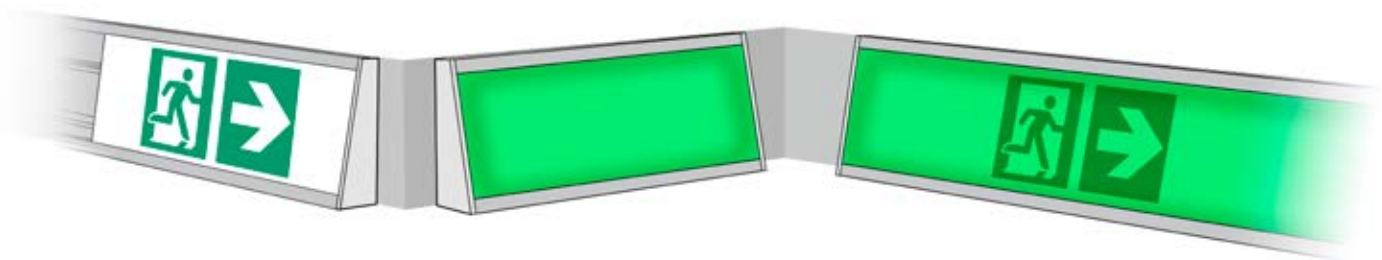

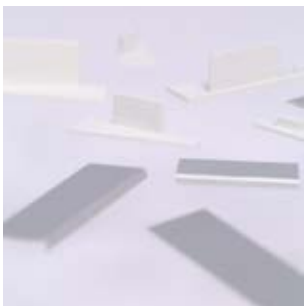

Ec End caps

Material	Quantity	Article
Plastic P / Aluminium, anodised A	20 pieces	0026

ASR A3.4/3

Width x Length	Application	Order-No. Price	Mat.	Article
18 x 54 mm	For flat profile 60 mm	5036 € 21,50	A	5036 € 21,50
18 x 74 mm	For flat profile 80 mm	5037 € 30,30	A	5037 € 30,30
12 x 60 mm	For angled profile 60 mm, left	5040 € 32,20	P	5040 € 32,20
12 x 60 mm	For angled profile 60 mm, right	5041 € 32,20	P	5041 € 32,20
12 x 80 mm	For angled profile 80 mm, left	5042 € 43,20	P	5042 € 43,20
12 x 80 mm	For angled profile 80 mm, right	5043 € 43,20	P	5043 € 43,20



Ts Transparent escape route signs

Material	Quantity	Article
Foil	10 pieces	0029

ASR A1.3

Width x Height	Order-No. Price	Image	Order-No. Price	Image	Order-No. Price
96 x 48 mm	300 € 22,20		302 € 22,20		303 € 22,20
134 x 67 mm	6844 € 25,50		6845 € 25,50		6846 € 25,50
96 x 48 mm	301 € 22,20		304 € 22,20		305 € 22,20
134 x 67 mm	6847 € 25,50		6848 € 25,50		6849 € 25,50



Exit door handle marking

Material	Luminance	Quantity	Article
Foil	Luxolight®	1 piece	0037

Width x Height	Design	Order-No.	Price
80 x 200 mm	With direction arrow left	336	€ 5,70
80 x 200 mm	With direction arrow right	337	€ 5,70



Stairway angles

Material	Luminance	Quantity	Article
Aluminium	Luxolight®	1 piece	0036

Width x Length	Application	Order-No.	Price
35 x 200 mm	For mounting on stairways	333	€ 8,60



Floor marking points, self-adhesive

Material	Luminance	Quantity	Article
Foil	Luxolight®	1 piece	0031

Diameter	Design	Order-No.	Price
Ø 100 mm	With direction arrow	5061	€ 2,50
Ø 200 mm	With direction arrow	5062	€ 3,90
Ø 100 mm	Without direction arrow	5065	€ 2,30
Ø 200 mm	Without direction arrow	5066	€ 4,30

Safety Signs



Safety signs are standardised in their message, graphical symbol and safety colours in order to ensure international understanding. Lawful safety identification includes rescue, fire protection, prohibitory, mandatory action and warning symbols.

The exact requirements for your working environment are already determined when the escape and rescue plans are drawn up during the workplace's planning phase; they are specified more precisely over the course of regular risk assessments. Our rescue and fire protection symbols are available in standard form or with a photoluminescent background. This is not the case for prohibitory, mandatory action and warning symbols; they are therefore delivered in the standard form on a white background.





Escape route signs

Material	Luminance	Quantity	Article
PVC P / Foil F	No <input type="checkbox"/> / Luxolight® <input type="checkbox"/>	1 piece	0040

ISO 7010



Width x Height		Mat.						
300 x 150 mm	Order-No.	P	24005	23975	24009	23979	24007	23977
	Price		€ 3,80	€ 10,70	€ 3,80	€ 10,70	€ 3,80	€ 10,70
400 x 200 mm	Order-No.	F	23935	23945	23939	23949	23937	23947
	Price		€ 3,60	€ 10,40	€ 3,60	€ 10,40	€ 3,60	€ 10,40
300 x 150 mm	Order-No.	P	24006	23976	24010	23980	24008	23978
	Price		€ 6,40	€ 13,40	€ 6,40	€ 13,40	€ 6,40	€ 13,40
400 x 200 mm	Order-No.	F	23936	23946	23940	23950	23938	23948
	Price		€ 6,10	€ 13,00	€ 6,10	€ 13,00	€ 6,10	€ 13,00



Width x Height		Mat.						
300 x 150 mm	Order-No.	P	24003	23973	24001	23971	23985	23995
	Price		€ 3,80	€ 10,70	€ 3,80	€ 10,70	€ 3,80	€ 10,70
400 x 200 mm	Order-No.	F	23933	23943	23931	23941	23955	23965
	Price		€ 3,60	€ 10,40	€ 3,60	€ 10,40	€ 3,60	€ 10,40
300 x 150 mm	Order-No.	P	24004	23974	24002	23972	23986	23996
	Price		€ 6,40	€ 13,40	€ 6,40	€ 13,40	€ 6,40	€ 13,40
400 x 200 mm	Order-No.	F	23934	23944	23932	23942	23956	23966
	Price		€ 6,10	€ 13,00	€ 6,10	€ 13,00	€ 6,10	€ 13,00



Width x Height		Mat.						
300 x 150 mm	Order-No.	P	23989	23999	23987	23997	23983	23993
	Price		€ 3,80	€ 10,70	€ 3,80	€ 10,70	€ 3,80	€ 10,70
400 x 200 mm	Order-No.	F	23959	23969	23957	23967	23953	23963
	Price		€ 3,60	€ 10,40	€ 3,60	€ 10,40	€ 3,60	€ 10,40
300 x 150 mm	Order-No.	P	23990	24000	23988	23998	23984	23994
	Price		€ 6,40	€ 13,40	€ 6,40	€ 13,40	€ 6,40	€ 13,40
400 x 200 mm	Order-No.	F	23960	23970	23958	23968	23954	23964
	Price		€ 6,10	€ 13,00	€ 6,10	€ 13,00	€ 6,10	€ 13,00







Width x Height		Mat.		
300 x 150 mm	Order-No.	P	23981	23991
	Price		€ 3,80	€ 10,70
400 x 200 mm	Order-No.	F	23951	23961
	Price		€ 3,60	€ 10,40
300 x 150 mm	Order-No.	P	23982	23992
	Price		€ 6,40	€ 13,40
400 x 200 mm	Order-No.	F	23952	23962
	Price		€ 6,10	€ 13,00

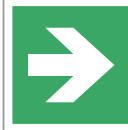

Escape route, emergency equipment and safety action signs



Material	Luminance	Quantity	Article
PVC P / Foil F	No <input type="checkbox"/> / Luxolight® <input type="checkbox"/>	1 piece	0040

ISO 7010											
Width x Height		Mat.		E001		E002		E003			
150 x 150 mm	Order-No. P	358	360	362	364	374	376	378	380	382	384
	Price	€ 2,50	€ 6,10	€ 2,50	€ 6,10	€ 2,50	€ 6,10	€ 2,50	€ 6,10	€ 2,50	€ 6,10
200 x 200 mm	Order-No. F	10084	10091	10093	10095	10107	10111	10113	10115	10117	10120
	Price	€ 2,30	€ 5,90	€ 2,30	€ 5,90	€ 2,30	€ 5,90	€ 2,30	€ 5,90	€ 2,30	€ 5,90
200 x 200 mm	Order-No. P	359	361	363	365	375	377	379	381	383	385
	Price	€ 3,00	€ 8,00	€ 3,00	€ 8,00	€ 3,00	€ 8,00	€ 3,00	€ 8,00	€ 3,00	€ 8,00
200 x 200 mm	Order-No. F	10090	10092	10094	10096	10108	10112	10114	10116	10118	10121
	Price	€ 2,70	€ 7,70	€ 2,70	€ 7,70	€ 2,70	€ 7,70	€ 2,70	€ 7,70	€ 2,70	€ 7,70

Width x Height		Mat.		E004		E007		E008		E009		E010	
150 x 150 mm	Order-No. P	386	388	390	393	396	398	400	402	404	406	404	406
	Price	€ 2,50	€ 6,10	€ 2,50	€ 6,10	€ 2,50	€ 6,10	€ 2,50	€ 6,10	€ 2,50	€ 6,10	€ 2,50	€ 6,10
200 x 200 mm	Order-No. F	10123	10125	10128	10131	10134	10136	10138	10140	10142	10144	10142	10144
	Price	€ 2,30	€ 5,90	€ 2,30	€ 5,90	€ 2,30	€ 5,90	€ 2,30	€ 5,90	€ 2,30	€ 5,90	€ 2,30	€ 5,90
200 x 200 mm	Order-No. P	387	389	391	394	397	399	401	403	405	407	405	407
	Price	€ 3,00	€ 8,00	€ 3,00	€ 8,00	€ 3,00	€ 8,00	€ 3,00	€ 8,00	€ 3,00	€ 8,00	€ 3,00	€ 8,00
200 x 200 mm	Order-No. F	10124	10126	10129	10132	10135	10137	10139	10141	10143	10145	10143	10145
	Price	€ 2,70	€ 7,70	€ 2,70	€ 7,70	€ 2,70	€ 7,70	€ 2,70	€ 7,70	€ 2,70	€ 7,70	€ 2,70	€ 7,70
400 x 400 mm	Order-No. P	-	-	392	395	-	-	-	-	-	-	-	-
	Price	-	-	€ 9,70	€ 27,70	-	-	-	-	-	-	-	-
400 x 400 mm	Order-No. F	-	-	10130	10133	-	-	-	-	-	-	-	-
	Price	-	-	€ 9,20	€ 27,50	-	-	-	-	-	-	-	-

Width x Height		Mat.		E011		E012		E013		E015		E016	
150 x 150 mm	Order-No. P	408	410	412	414	416	418	37441	37443	420	422	420	422
	Price	€ 2,50	€ 6,10	€ 2,50	€ 6,10	€ 2,50	€ 6,10	€ 2,50	€ 6,10	€ 2,50	€ 6,10	€ 2,50	€ 6,10
200 x 200 mm	Order-No. F	10146	10148	10150	10152	10154	10157	37437	37439	10159	10161	10159	10161
	Price	€ 2,30	€ 5,90	€ 2,30	€ 5,90	€ 2,30	€ 5,90	€ 2,30	€ 5,90	€ 2,30	€ 5,90	€ 2,30	€ 5,90
200 x 200 mm	Order-No. P	409	411	413	415	417	419	37442	37444	421	423	421	423
	Price	€ 3,00	€ 8,00	€ 3,00	€ 8,00	€ 3,00	€ 8,00	€ 3,00	€ 8,00	€ 3,00	€ 8,00	€ 3,00	€ 8,00
200 x 200 mm	Order-No. F	10147	10149	10151	10153	10155	10158	37438	37440	10160	10162	10160	10162
	Price	€ 2,70	€ 7,70	€ 2,70	€ 7,70	€ 2,70	€ 7,70	€ 2,70	€ 7,70	€ 2,70	€ 7,70	€ 2,70	€ 7,70

Width x Height		Mat.		E017		E018		E019		D-E019		WSE001	
150 x 150 mm	Order-No. P	424	426	428	430	432	434	366	368	370	372	370	372
	Price	€ 2,50	€ 6,10	€ 2,50	€ 6,10	€ 2,50	€ 6,10	€ 2,50	€ 6,10	€ 2,50	€ 6,10	€ 2,50	€ 6,10
200 x 200 mm	Order-No. F	10163	10167	10169	10171	10173	10175	10098	10101	10103	10105	10103	10105
	Price	€ 2,30	€ 5,90	€ 2,30	€ 5,90	€ 2,30	€ 5,90	€ 2,30	€ 5,90	€ 2,30	€ 5,90	€ 2,30	€ 5,90
200 x 200 mm	Order-No. P	425	427	429	431	433	435	367	369	371	373	371	373
	Price	€ 3,00	€ 8,00	€ 3,00	€ 8,00	€ 3,00	€ 8,00	€ 3,00	€ 8,00	€ 3,00	€ 8,00	€ 3,00	€ 8,00
200 x 200 mm	Order-No. F	10166	10168	10170	10172	10174	10176	10099	10102	10104	10106	10104	10106
	Price	€ 2,70	€ 7,70	€ 2,70	€ 7,70	€ 2,70	€ 7,70	€ 2,70	€ 7,70	€ 2,70	€ 7,70	€ 2,70	€ 7,70





													
<i>Width x Height</i>		<i>Mat.</i>		E020		E021		E022		E023		E024	
150 x 150 mm	Order-No.	P	37449	37451	37457	37459	37465	37467	37473	37475	37481	37483	
	Price		€ 2,50	€ 6,10	€ 2,50	€ 6,10	€ 2,50	€ 6,10	€ 2,50	€ 6,10	€ 2,50	€ 6,10	
200 x 200 mm	Order-No.	F	37445	37447	37453	37455	37461	37463	37469	37471	37477	37479	
	Price		€ 2,30	€ 5,90	€ 2,30	€ 5,90	€ 2,30	€ 5,90	€ 2,30	€ 5,90	€ 2,30	€ 5,90	
150 x 150 mm	Order-No.	P	37450	37452	37458	37460	37466	37468	37474	37476	37482	37484	
	Price		€ 3,00	€ 8,00	€ 3,00	€ 8,00	€ 3,00	€ 8,00	€ 3,00	€ 8,00	€ 3,00	€ 8,00	
200 x 200 mm	Order-No.	F	37446	37448	37454	37456	37462	37464	37470	37472	37478	37480	
	Price		€ 2,70	€ 7,70	€ 2,70	€ 7,70	€ 2,70	€ 7,70	€ 2,70	€ 7,70	€ 2,70	€ 7,70	





													
<i>Width x Height</i>		<i>Mat.</i>		E025		E057		E058		E059		E060	
150 x 150 mm	Order-No.	P	37489	37491	37497	37499	37505	37507	37513	37515	37521	37523	
	Price		€ 2,50	€ 6,10	€ 2,50	€ 6,10	€ 2,50	€ 6,10	€ 2,50	€ 6,10	€ 2,50	€ 6,10	
200 x 200 mm	Order-No.	F	37485	37487	37493	37495	37501	37503	37509	37511	37517	37519	
	Price		€ 2,30	€ 5,90	€ 2,30	€ 5,90	€ 2,30	€ 5,90	€ 2,30	€ 5,90	€ 2,30	€ 5,90	
150 x 150 mm	Order-No.	P	37490	37492	37498	37500	37506	37508	37514	37516	37522	37524	
	Price		€ 3,00	€ 8,00	€ 3,00	€ 8,00	€ 3,00	€ 8,00	€ 3,00	€ 8,00	€ 3,00	€ 8,00	
200 x 200 mm	Order-No.	F	37486	37488	37494	37496	37502	37504	37510	37512	37518	37520	
	Price		€ 2,70	€ 7,70	€ 2,70	€ 7,70	€ 2,70	€ 7,70	€ 2,70	€ 7,70	€ 2,70	€ 7,70	



Fire fighting equipment signs

Material	Luminance	Quantity	Article
PVC P / Foil F	No <input type="checkbox"/> / Luxolight® <input type="checkbox"/>	1 piece	0046

ISO 7010											
Width x Height	Mat.	-		-		F001		F002		F003	
150 x 150 mm	Order-No. P	2577	2579	5025	5027	2581	2583	2585	2587	2589	2591
	Price	€ 2,50	€ 6,10	€ 2,50	€ 6,10	€ 2,50	€ 6,10	€ 2,50	€ 6,10	€ 2,50	€ 6,10
200 x 200 mm	Order-No. F	10178	10180	10182	10184	10186	10188	10191	10190	10195	10197
	Price	€ 2,30	€ 5,90	€ 2,30	€ 5,90	€ 2,30	€ 5,90	€ 2,30	€ 5,90	€ 2,30	€ 5,90
200 x 200 mm	Order-No. P	2578	2580	5026	5028	2582	2584	2586	2588	2590	2592
	Price	€ 3,00	€ 8,00	€ 3,00	€ 8,00	€ 3,00	€ 8,00	€ 3,00	€ 8,00	€ 3,00	€ 8,00
200 x 200 mm	Order-No. F	10179	10181	10183	10185	10187	10189	10192	10194	10196	10198
	Price	€ 2,70	€ 7,70	€ 2,70	€ 7,70	€ 2,70	€ 7,70	€ 2,70	€ 7,70	€ 2,70	€ 7,70





											
Width x Height	Mat.	F004		F005		F006		F007		F016	
150 x 150 mm	Order-No. P	2593	2595	2597	2599	2601	2603	37529	37531	37537	37539
	Price	€ 2,50	€ 6,10	€ 2,50	€ 6,10	€ 2,50	€ 6,10	€ 2,50	€ 6,10	€ 2,50	€ 6,10
200 x 200 mm	Order-No. F	10199	10201	10204	10206	10208	10210	37525	37527	37533	37535
	Price	€ 2,30	€ 5,90	€ 2,30	€ 5,90	€ 2,30	€ 5,90	€ 2,30	€ 5,90	€ 2,30	€ 5,90
200 x 200 mm	Order-No. P	2594	2596	2598	2600	2602	2604	37530	37532	37538	37540
	Price	€ 3,00	€ 8,00	€ 3,00	€ 8,00	€ 3,00	€ 8,00	€ 3,00	€ 8,00	€ 3,00	€ 8,00
200 x 200 mm	Order-No. F	10200	10202	10205	10207	10209	10211	37526	37528	37534	37536
	Price	€ 2,70	€ 7,70	€ 2,70	€ 7,70	€ 2,70	€ 7,70	€ 2,70	€ 7,70	€ 2,70	€ 7,70



















Prohibition Signs

Material	Luminance	Quantity					Article
PVC	No <input type="checkbox"/>	1 piece					0049
ISO 7010							
<i>Width x Height</i>							
150 x 150 mm	Order-No. Price	P001 2756 € 2,60	P002 2758 € 2,60	P003 2760 € 2,60	P004 2762 € 2,60	P005 2764 € 2,60	
200 x 200 mm	Order-No. Price	2757 € 3,10	2759 € 3,10	2761 € 3,10	2763 € 3,10	2765 € 3,10	
<i>Width x Height</i>							
150 x 150 mm	Order-No. Price	P006 2766 € 2,60	P007 2768 € 2,60	P008 2770 € 2,60	P010 2772 € 2,60	P011 2774 € 2,60	
200 x 200 mm	Order-No. Price	2767 € 3,10	2769 € 3,10	2771 € 3,10	2773 € 3,10	2775 € 3,10	
<i>Width x Height</i>							
150 x 150 mm	Order-No. Price	P012 2776 € 2,60	P013 2778 € 2,60	P014 2780 € 2,60	P015 2782 € 2,60	P017 2784 € 2,60	
200 x 200 mm	Order-No. Price	2777 € 3,10	2779 € 3,10	2781 € 3,10	2783 € 3,10	2785 € 3,10	
<i>Width x Height</i>							
150 x 150 mm	Order-No. Price	P018 2786 € 2,60	P019 2788 € 2,60	P020 2790 € 2,60	P021 2792 € 2,60	P022 2794 € 2,60	
200 x 200 mm	Order-No. Price	2787 € 3,10	2789 € 3,10	2791 € 3,10	2793 € 3,10	2795 € 3,10	
<i>Width x Height</i>							
150 x 150 mm	Order-No. Price	P023 2796 € 2,60	P024 2798 € 2,60	P025 2800 € 2,60	P026 2802 € 2,60	P027 2804 € 2,60	
200 x 200 mm	Order-No. Price	2797 € 3,10	2799 € 3,10	2801 € 3,10	2803 € 3,10	2805 € 3,10	

					
	P028	P029	P030	P031	P032
150 x 150 mm	Order-No. 2806	Order-No. 2808	Order-No. 2810	Order-No. 2812	Order-No. 2814
	Price € 2,60	Price € 2,60	Price € 2,60	Price € 2,60	Price € 2,60
200 x 200 mm	Order-No. 2807	Order-No. 2809	Order-No. 2811	Order-No. 2813	Order-No. 2815
	Price € 3,10	Price € 3,10	Price € 3,10	Price € 3,10	Price € 3,10

					
	P033	P034	P035	P039	P041
150 x 150 mm	Order-No. 2816	Order-No. 2818	Order-No. 37543	Order-No. 37545	Order-No. 37547
	Price € 2,60	Price € 2,60	Price € 2,60	Price € 2,60	Price € 2,60
200 x 200 mm	Order-No. 2817	Order-No. 2819	Order-No. 37544	Order-No. 37546	Order-No. 37548
	Price € 3,10	Price € 3,10	Price € 3,10	Price € 3,10	Price € 3,10

					
	P042	P043	P044	P049	P052
150 x 150 mm	Order-No. 37549	Order-No. 37551	Order-No. 37553	Order-No. 37555	Order-No. 37557
	Price € 2,60	Price € 2,60	Price € 2,60	Price € 2,60	Price € 2,60
200 x 200 mm	Order-No. 37550	Order-No. 37552	Order-No. 37554	Order-No. 37556	Order-No. 37558
	Price € 3,10	Price € 3,10	Price € 3,10	Price € 3,10	Price € 3,10

			
WSP001	D-P006	D-P016	D-P022
Order-No. 2826	Order-No. 2820	Order-No. 2822	Order-No. 2824
Price € 2,60	Price € 2,60	Price € 2,60	Price € 2,60
Order-No. 2827	Order-No. 2821	Order-No. 2823	Order-No. 2825
Price € 3,10	Price € 3,10	Price € 3,10	Price € 3,10



Warning signs

Material	Luminance	Quantity	Article
PVC	No <input type="checkbox"/>	1 piece	0051

ISO 7010						
		W001	W002	W003	W004	W005
Width x Height						
150 x 150 mm	Order-No. Price	2940 € 2,60	2942 € 2,60	2944 € 2,60	2946 € 2,60	2948 € 2,60
200 x 200 mm	Order-No. Price	2941 € 3,10	2943 € 3,10	2945 € 3,10	2947 € 3,10	2949 € 3,10

		W006	W007	W008	W009	W010
Width x Height						
150 x 150 mm	Order-No. Price	2950 € 2,60	2952 € 2,60	2954 € 2,60	2956 € 2,60	2958 € 2,60
200 x 200 mm	Order-No. Price	2951 € 3,10	2953 € 3,10	2955 € 3,10	2957 € 3,10	2959 € 3,10

		W011	W012	W013	W014	W015
Width x Height						
150 x 150 mm	Order-No. Price	2960 € 2,60	2962 € 2,60	2964 € 2,60	2966 € 2,60	2968 € 2,60
200 x 200 mm	Order-No. Price	2961 € 3,10	2963 € 3,10	2965 € 3,10	2967 € 3,10	2969 € 3,10

		W016	W017	W018	W019	W020
Width x Height						
150 x 150 mm	Order-No. Price	2970 € 2,60	2972 € 2,60	2974 € 2,60	2976 € 2,60	2978 € 2,60
200 x 200 mm	Order-No. Price	2971 € 3,10	2973 € 3,10	2975 € 3,10	2977 € 3,10	2979 € 3,10

		W021	D-W021	W022	D-W022	W023
Width x Height						
150 x 150 mm	Order-No. Price	2980 € 2,60	2998 € 2,60	2982 € 2,60	3000 € 2,60	2984 € 2,60
200 x 200 mm	Order-No. Price	2981 € 3,10	2999 € 3,10	2983 € 3,10	3001 € 3,10	2985 € 3,10

		W024	W025	W026	W027	W028
<i>Width x Height</i>		2986	2988	2990	2992	2994
150 x 150 mm	Order-No.	€ 2,60	€ 2,60	€ 2,60	€ 2,60	€ 2,60
	Price					
200 x 200 mm	Order-No.	2987	2989	2991	2993	2995
	Price	€ 3,10	€ 3,10	€ 3,10	€ 3,10	€ 3,10





		W029	W030	W033	W035	W037
<i>Width x Height</i>		2996	37559	37561	37563	37565
150 x 150 mm	Order-No.	€ 2,60	€ 2,60	€ 2,60	€ 2,60	€ 2,60
	Price					
200 x 200 mm	Order-No.	2997	37560	37562	37564	37566
	Price	€ 3,10	€ 3,10	€ 3,10	€ 3,10	€ 3,10





		W038	W041	W042	W055
<i>Width x Height</i>		37567	37569	37571	37573
150 x 150 mm	Order-No.	€ 2,60	€ 2,60	€ 2,60	€ 2,60
	Price				
200 x 200 mm	Order-No.	37568	37570	37572	37574
	Price	€ 3,10	€ 3,10	€ 3,10	€ 3,10





Mandatory action signs

Material	Luminance	Quantity					Article
PVC	No <input type="checkbox"/>	1 piece					0053
ISO 7010							
		M001	M002	M003	M004	M005	
<i>Width x Height</i>							
150 x 150 mm	Order-No. Price	3124 € 2,60	3126 € 2,60	3128 € 2,60	3130 € 2,60	3132 € 2,60	
200 x 200 mm	Order-No. Price	3125 € 3,10	3127 € 3,10	3129 € 3,10	3131 € 3,10	3133 € 3,10	
		M006	M007	M008	M009	M010	
<i>Width x Height</i>							
150 x 150 mm	Order-No. Price	3134 € 2,60	3136 € 2,60	3138 € 2,60	3140 € 2,60	3142 € 2,60	
200 x 200 mm	Order-No. Price	3135 € 3,10	3137 € 3,10	3139 € 3,10	3141 € 3,10	3143 € 3,10	
		M011	M012	M013	M014	M015	
<i>Width x Height</i>							
150 x 150 mm	Order-No. Price	3144 € 2,60	3146 € 2,60	3148 € 2,60	3150 € 2,60	3152 € 2,60	
200 x 200 mm	Order-No. Price	3145 € 3,10	3147 € 3,10	3149 € 3,10	3151 € 3,10	3153 € 3,10	
		M016	M017	M018	M019	M020	
<i>Width x Height</i>							
150 x 150 mm	Order-No. Price	3154 € 2,60	3156 € 2,60	3158 € 2,60	3160 € 2,60	3162 € 2,60	
200 x 200 mm	Order-No. Price	3155 € 3,10	3157 € 3,10	3159 € 3,10	3161 € 3,10	3163 € 3,10	
		M021	M022	M023	M024	M025	
<i>Width x Height</i>							
150 x 150 mm	Order-No. Price	3164 € 2,60	3166 € 2,60	3168 € 2,60	3170 € 2,60	3172 € 2,60	
200 x 200 mm	Order-No. Price	3165 € 3,10	3167 € 3,10	3169 € 3,10	3171 € 3,10	3173 € 3,10	

<i>Width x Height</i>						
		M026	M027	M028	M029	M030
150 x 150 mm	Order-No. Price	3174 € 2,60	37575 € 2,60	37591 € 2,60	37593 € 2,60	37577 € 2,60
200 x 200 mm	Order-No. Price	3175 € 3,10	37576 € 3,10	37592 € 3,10	37594 € 3,10	37578 € 3,10

<i>Width x Height</i>						
		M031	M032	M046	M047	M048
150 x 150 mm	Order-No. Price	37579 € 2,60	37581 € 2,60	37583 € 2,60	37585 € 2,60	37587 € 2,60
200 x 200 mm	Order-No. Price	37580 € 3,10	37582 € 3,10	37584 € 3,10	37586 € 3,10	37588 € 3,10

<i>Width x Height</i>			
		M054	WSM001
150 x 150 mm	Order-No. Price	37589 € 2,60	3180 € 2,60
200 x 200 mm	Order-No. Price	37590 € 3,10	3181 € 3,10

In some cases, safety identification might be even more effective if placed on the ground. These self-adhesive sticker signs can be applied directly to the ground but the edges should be sealed in order to avoid premature wear. Our floor signs are slip resistant to prevent slip hazard.



Floor marking (antislipping)

Material	Slip-prevention	Quantity	Article		
Foil	R 10	1 piece	0056		
Diameter	M001	M003	M004	M008	M009
Ø 300 mm	Order-No. 3290 Price € 25,80	Order-No. 3291 Price € 25,80	Order-No. 3292 Price € 25,80	Order-No. 3293 Price € 25,80	Order-No. 3294 Price € 25,80
Diameter	M012	M014	M024		
Ø 300 mm	Order-No. 3295 Price € 25,80	Order-No. 3296 Price € 25,80	Order-No. 3297 Price € 25,80		
Diameter	P001	P002	P004	P006	P012
Ø 300 mm	Order-No. 3298 Price € 25,80	Order-No. 3299 Price € 25,80	Order-No. 3300 Price € 25,80	Order-No. 3301 Price € 25,80	Order-No. 3302 Price € 25,80
Diameter	P023	P024	D-P006		
Ø 300 mm	Order-No. 3303 Price € 25,80	Order-No. 3304 Price € 25,80	Order-No. 3289 Price € 25,80		
Seitenlänge	W001	W007	W014	W015	D-W021
300 mm	Order-No. 3305 Price € 25,80	Order-No. 3306 Price € 25,80	Order-No. 3307 Price € 25,80	Order-No. 3308 Price € 25,80	Order-No. 3288 Price € 25,80

Safety Markings for Obstacles and Hazardous Areas

Whether for everyday or emergency purposes, labelling obstacles and hazardous areas is an integral part of comprehensive safety identification. A colour design is recommended for day-to-day operations, but for workplaces where no complex safety lighting is installed, a safety marking in the form of photoluminescent marking tape is preferable.



Marking tapes

Material	Quantity	Article
Foil	1 piece	0058

Width x Length	Application	Colours	Order-No.	Price
40 mm x 25 m	permanent danger warning		2746	€ 40,00
40 mm x 25 m	temporary danger warning		2740	€ 40,00
80 mm x 25 m	permanent danger warning		2747	€ 71,90
80 mm x 25 m	temporary danger warning		2741	€ 71,90

ISO 3864



















Width x Length	Application	Colours	Order-No.	Price
40 mm x 25 m	command signal		2742	€ 40,00
40 mm x 25 m	safe situation		2744	€ 40,00
80 mm x 25 m	command signal		2743	€ 71,90
80 mm x 25 m	safe situation		2745	€ 71,90

Floor marking and Anti-Slip tapes

The labelling of passage ways in accordance with ASR A1.8 is mandatory. What's more, due to the frequency and severity of slip accidents floor marking tapes and anti-slip floorings play an increasingly important role within safety and health systems. In the following you can find a selection of products to maintain the safety of your facility and further prevent and reduce these kind of accidents. Anti-slip floorings help to prevent slip accidents on indoor and outdoor surfaces that are slick, slippery, wet and/or soiled by oil or grease. These products might be used for labelling of entrance areas, passageways, walkways, stairs, ascents, ramps, machines, vehicles, kitchen and canteens, terraces, shelters etc.



Floor marking tapes

Material		Quantity	Article
PVC		1 piece	0108
Width x Length	Design	Colours	
50 mm x 33 m	black		Order-No. 36801 Price € 7,80
75 mm x 33 m			Order-No. 36802 Price € 11,70
50 mm x 33 m	yellow		Order-No. 36803 Price € 7,80
75 mm x 33 m			Order-No. 36804 Price € 11,70
50 mm x 33 m	blue		Order-No. 36805 Price € 7,80
75 mm x 33 m			Order-No. 36806 Price € 11,70
50 mm x 33 m	red		Order-No. 36807 Price € 7,80
75 mm x 33 m			Order-No. 36808 Price € 11,70
50 mm x 33 m	green		Order-No. 36809 Price € 7,80
75 mm x 33 m			Order-No. 36810 Price € 11,70
50 mm x 33 m	white		Order-No. 36811 Price € 7,80
75 mm x 33 m			Order-No. 36812 Price € 11,70
50 mm x 33 m	orange		Order-No. 36813 Price € 7,80
75 mm x 33 m			Order-No. 36814 Price € 11,70
50 mm x 33 m	black/yellow striped		Order-No. 36815 Price € 10,50
75 mm x 33 m			Order-No. 36816 Price € 15,80
50 mm x 33 m	red/white striped		Order-No. 36817 Price € 10,50
75 mm x 33 m			Order-No. 36818 Price € 15,80



Anti-slip tape, general purpose

Material	Slip-prevention	Luminance (after 10 min.)	Quantity	Article
PVC Grit Carrying Web	R 13	No <input type="checkbox"/> / 150 mcd/m ² <input type="checkbox"/>	1 piece	0108

Width x Length	Design	Colours	Order-No.	Price
50 mm x 18,3 m	black		36819	€ 66,00
75 mm x 18,3 m			36820	€ 99,00
50 mm x 18,3 m	yellow		36821	€ 66,00
75 mm x 18,3 m			36822	€ 99,00
50 mm x 18,3 m	white		36823	€ 66,00
75 mm x 18,3 m			36824	€ 99,00
50 mm x 18,3 m	grey		36825	€ 66,00
75 mm x 18,3 m			36826	€ 99,00
50 mm x 18,3 m	blue		36827	€ 66,00
75 mm x 18,3 m			36828	€ 99,00
50 mm x 18,3 m	red		36829	€ 66,00
75 mm x 18,3 m			36830	€ 99,00
50 mm x 18,3 m	green		36831	€ 66,00
75 mm x 18,3 m			36832	€ 99,00
50 mm x 18,3 m	brown		36833	€ 66,00
75 mm x 18,3 m			36834	€ 99,00
50 mm x 18,3 m	black/yellow striped		36835	€ 79,50
75 mm x 18,3 m			36836	€ 119,30
50 mm x 18,3 m	red/white striped		36837	€ 79,50
75 mm x 18,3 m			36838	€ 119,30
50 mm x 18,3 m	luminescent		36839	€ 243,00
100 mm x 18,3 m			36840	€ 486,00
50 mm x 18,3 m	black/luminescent striped		36841	€ 267,00
100 mm x 18,3 m			36842	€ 534,00
50 mm x 18,3 m	black - extra strong		36867	€ 127,50
75 mm x 18,3 m			36868	€ 191,30



Anti-slip tape, easy clean

Material	Slip-prevention	Quantity	Article
PVC Grit Carrying Web	R 10	1 piece	0108

Width x Length	Design	Colours	Order-No.	Price
50 mm x 18,3 m	black		36843	€ 78,00
100 mm x 18,3 m			36844	€ 156,00
50 mm x 18,3 m	yellow		36845	€ 78,00
100 mm x 18,3 m			36846	€ 156,00
50 mm x 18,3 m	clear		36847	€ 78,00
100 mm x 18,3 m			36848	€ 156,00
50 mm x 18,3 m	grey		36849	€ 78,00
100 mm x 18,3 m			36850	€ 156,00
50 mm x 18,3 m	blue		36851	€ 78,00
100 mm x 18,3 m			36852	€ 156,00
50 mm x 18,3 m	red		36853	€ 78,00
100 mm x 18,3 m			36854	€ 156,00
50 mm x 18,3 m	green		36855	€ 78,00
100 mm x 18,3 m			36856	€ 156,00
50 mm x 18,3 m	white		36857	€ 78,00
100 mm x 18,3 m			36858	€ 156,00
50 mm x 18,3 m	black/yellow		36859	€ 93,80
100 mm x 18,3 m			36860	€ 187,50



Anti-slip tape, coarse grade

Material	Slip-prevention	Quantity	Article
Aluminium	R 13	1 piece	0108

Width x Length	Design	Colours	Order-No.	Price
50 mm x 18,3 m	black		36861	€ 79,50
100 mm x 18,3 m			36862	€ 159,00
50 mm x 18,3 m	yellow		36863	€ 79,50
100 mm x 18,3 m			36864	€ 159,00
50 mm x 18,3 m	black/yellow striped		36865	€ 79,50
100 mm x 18,3 m			36866	€ 159,00
50 mm x 18,3 m	black/coarse conformable		36869	€ 141,00
100 mm x 18,3 m			36870	€ 282,00

Knuffi® Warning and Protection Profiles



Warning and protection profiles effectively prevent impact injuries. Due to their striking colour in accordance with ASR A1.3, they caution you about the threat of collisions. Knuffi® products are made from flexible polyurethane foam using a patented process. They provide a visual warning through the specific colours and the material absorbs even the hardest impacts with ease.

Corner protection, self adhesive

Material	Luminance (after 10 min.)	Quantity	Article
Polyurethane foam	No <input type="checkbox"/> / 155 mcd/m ² <input type="checkbox"/>	1 m / 5 m	0059

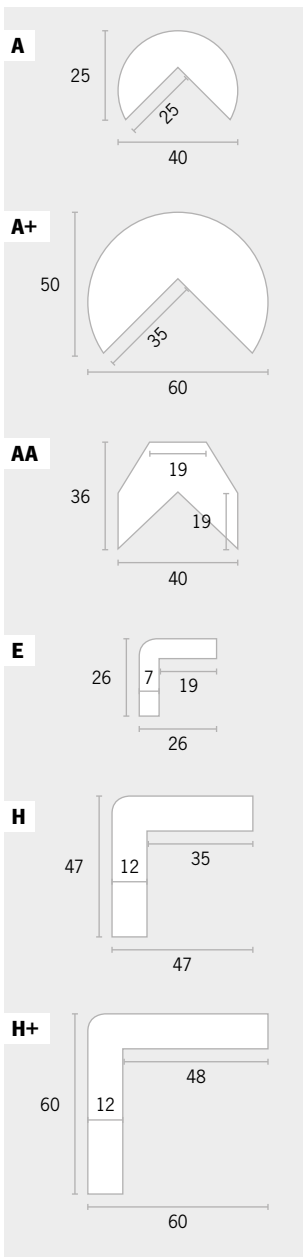

Type	Design	Colours	Order-No.	1 m	5 m
A	black/yellow		3317 Price € 26,60	3413 € 156,00	
A	red/white		3318 Price € 31,00	3414 € 184,30	
A	white		3319 Price € 32,50	3415 € 192,20	
A	black/daylight fluorescent		3320 Price € 35,20	-	
A	black/luminescent		3321 Price € 49,30	-	
A	black		3322 Price € 30,00	3418 € 176,30	
A+	black/yellow		3323 Price € 57,30	-	
A+	red/white		3324 Price € 57,30	-	
A+	white		3325 Price € 57,30	-	
A+	black		3328 Price € 57,30	-	
AA	black/yellow		3329 Price € 25,60	3425 € 150,40	
AA	red/white		3330 Price € 30,00	3426 € 177,50	
AA	white		3331 Price € 31,40	3427 € 184,80	
AA	black		3334 Price € 28,90	3430 € 169,60	
E	black/yellow		3335 Price € 26,60	3431 € 156,00	
E	red/white		3336 Price € 31,00	3432 € 184,30	
E	white		3337 Price € 32,50	3433 € 192,20	
E	black		3340 Price € 30,00	3436 € 176,30	
H	black/yellow		3341 Price € 31,20	3437 € 176,00	
H	red/white		3342 Price € 37,70	3438 € 212,10	
H	white		3343 Price € 39,40	3439 € 221,50	
H	black		3346 Price € 35,60	3442 € 203,20	
H+	black/yellow		3347 Price € 52,40	-	
H+	red/white		3348 Price € 52,40	-	
H+	white		3349 Price € 52,40	-	
H+	black		3352 Price € 52,40	-	

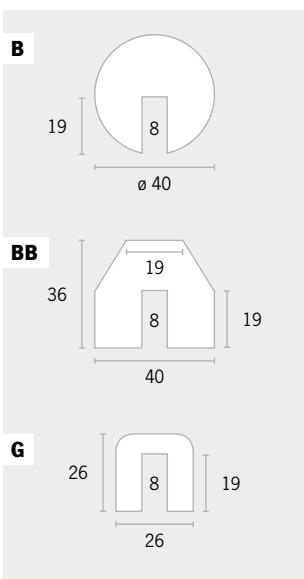

Edge protection

Material	Luminance (after 10 min.)	Quantity	Article
Polyurethane foam	No <input type="checkbox"/> / 155 mcd/m ² <input type="checkbox"/>	1 m / 5 m	0059

Type	Design	Colours	1 m	5 m
B	black/yellow		Order-No. 3359 Price € 22,60	3455 € 125,90
B	red/white		Order-No. 3360 Price € 30,40	3456 € 182,20
B	white		Order-No. 3361 Price € 31,50	3457 € 190,00
B	black/daylight fluorescent		Order-No. 3362 Price € 34,20	-
B	black/luminescent		Order-No. 3363 Price € 49,30	-
B	black		Order-No. 3364 Price € 28,90	3460 € 174,20
BB	black/yellow		Order-No. 3353 Price € 21,80	3449 € 120,40
BB	red/white		Order-No. 3354 Price € 30,00	3450 € 173,30
BB	white		Order-No. 3355 Price € 30,50	3451 € 181,20
BB	black		Order-No. 3358 Price € 27,90	3454 € 165,80
G	black/yellow		Order-No. 3365 Price € 24,90	3461 € 132,90
G	red/white		Order-No. 3366 Price € 34,60	3462 € 199,50
G	white		Order-No. 3367 Price € 35,70	3463 € 208,50
G	black		Order-No. 3370 Price € 33,10	3466 € 191,10

Piping protection, self adhesive

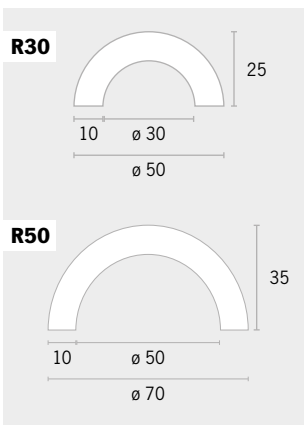

Material	Quantity	Article
Polyurethane foam	1 m / 5 m	0059

Type	Design	Colours	1 m	5 m
R30	black/yellow		Order-No. 3371 Price € 41,50	3467 € 225,30
R30	red/white		Order-No. 3372 Price € 51,50	3468 € 286,20
R30	white		Order-No. 3373 Price € 54,10	3469 € 298,80
R30	black		Order-No. 3376 Price € 49,30	3472 € 274,00
R50	black/yellow		Order-No. 3377 Price € 53,80	-
R50	red/white		Order-No. 3378 Price € 66,70	-
R50	white		Order-No. 3379 Price € 69,90	-
R50	black		Order-No. 3382 Price € 64,00	-



Surface protection, self adhesive

Material	Luminance (after 10 min.)	Quantity	Article
Polyurethane foam	No <input type="checkbox"/> / 155 mcd/m ² <input type="checkbox"/>	1 m / 5 m	0059

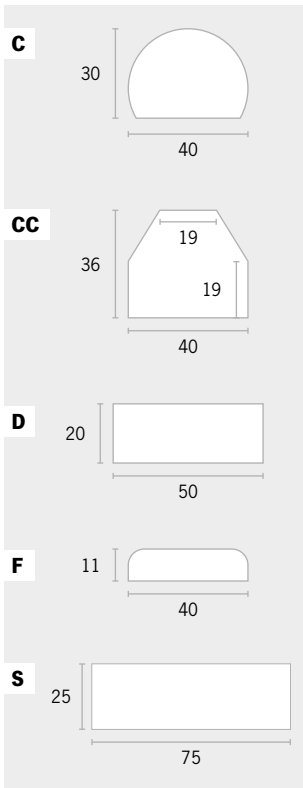

Type	Design	Colours	Order-No.	1 m	5 m
C	black/yellow		3407 Price € 27,20	3503 € 159,40	
C	red/white		3408 Price € 32,50	3504 € 191,00	
C	white		3409 Price € 33,50	3505 € 199,00	
C	black/daylight fluorescent		3410 Price € 36,80	-	
C	black/luminescent		3411 Price € 51,40	-	
C	black		3412 Price € 31,00	3508 € 182,60	
CC	black/yellow		3401 Price € 26,30	3497 € 154,80	
CC	red/white		3402 Price € 31,00	3498 € 184,80	
CC	white		3403 Price € 32,50	3499 € 193,10	
CC	black		3406 Price € 30,00	3502 € 177,00	
D	black/yellow		3383 Price € 31,10	3479 € 166,40	
D	red/white		3384 Price € 41,50	3480 € 228,40	
D	white		3385 Price € 43,00	3481 € 237,30	
D	black		3388 Price € 39,40	3484 € 217,90	
F	black/yellow		3395 Price € 27,20	3491 € 159,40	
F	red/white		3396 Price € 32,50	3492 € 191,10	
F	white		3397 Price € 33,50	3493 € 199,00	
F	black		3400 Price € 31,00	3496 € 182,60	
S	black/yellow		3389 Price € 57,30	-	
S	red/white		3390 Price € 57,30	-	
S	white		3391 Price € 57,30	-	
S	black		3394 Price € 57,30	-	

Plans for Safety Identification

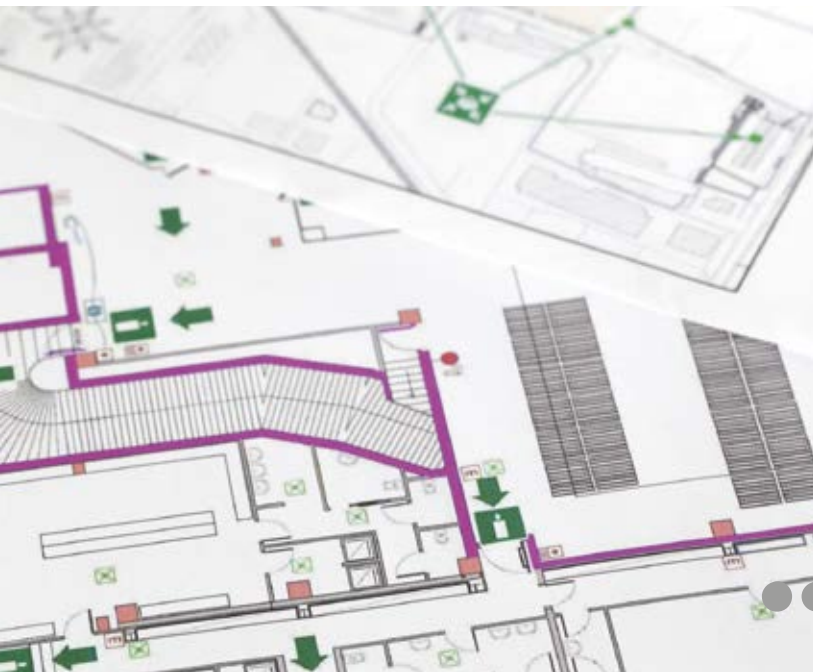

The displayed information for employees and visitors in buildings is an integral part of safety identification. For this reason, our qualified inhouse CAD department specialises in preventive fire protection. We prepare, deliver and install the necessary plans for you in compliance with all relevant laws, regulations, guidelines and standards.

A professional on-site audit is the basis for all plans; a regular inventory check also ensures the safety of your property. According to the technical rule ASR A2.3 „Escape and rescue routes and emergency exits, escape route plans“, all put up plans must always be up-to-date. Any structural or fire protection changes must result in an adjustment of your plans.

We will perform this review for you. If available, the existing plans establish the starting position. If you do not have a floor plan, we will also draw up new plans – which includes surveying the on-site layout with a handheld laser device – as part of our service. Within the context of the property inspection, an expert conducts a variance analysis of your situation. Amongst other things, this analysis takes into consideration

the location of the emergency, rescue and fire fighting equipment, the path of the escape and rescue routes and the safety signage in the building. After all of the important information has been definitively registered, the final alignment with the relevant authorities (e.g. fire brigade, fire protection services, building authorities) can be conducted on request.

Upon approval of the authorities the plans will be handed out in printed or digital form.

Within the scope of safety identification we offer you the following plans, among others:

Escape and rescue plan

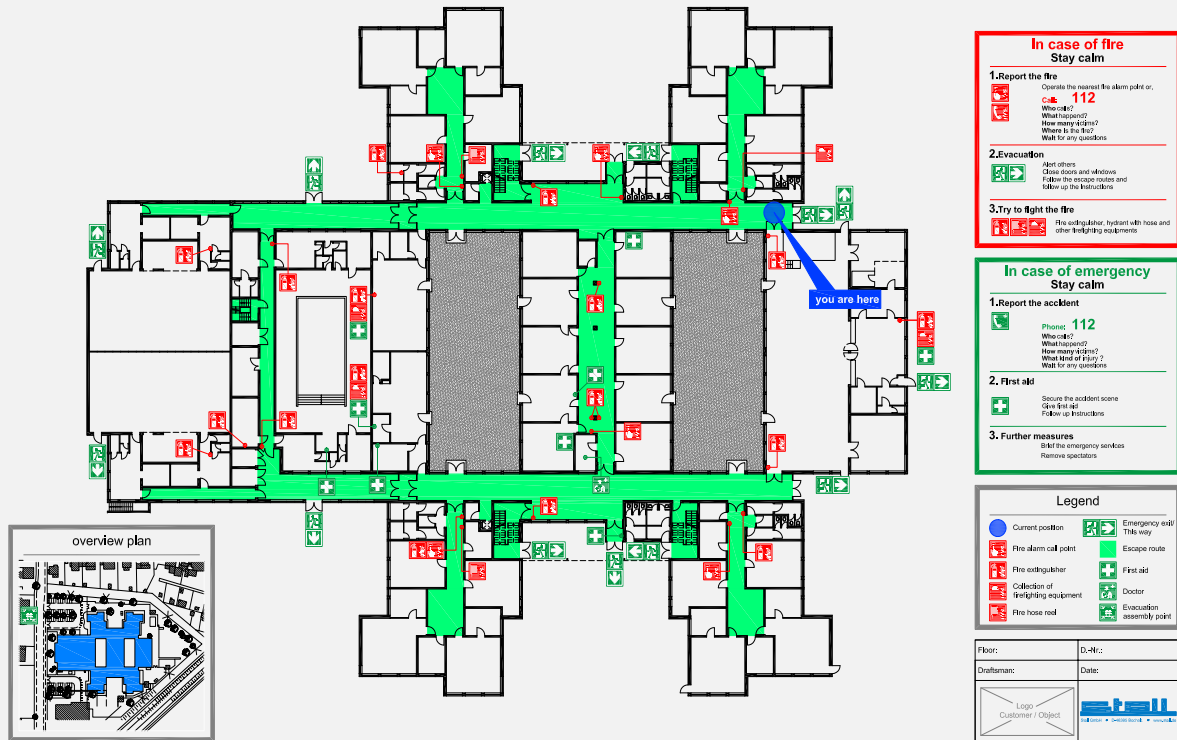

In case of fire
Stay calm

- 1. Report the fire**
 Go into the nearest fire alarm point or:
 Call **112**
 Who call?
 What happened?
 How many people?
 Where is the fire?
 Wait for any questions
- 2. Evacuation**
 Alert others
 Close doors and windows
 Follow the escape routes and
 follow up the instructions
- 3. Try to fight the fire**
 Fire extinguisher, hydrant with hose and
 other firefighting equipment

In case of emergency
Stay calm

- 1. Report the accident**
 Phone: **112**
 Who call?
 What happened?
 How many people?
 What kind of injury?
 Wait for any questions
- 2. First aid**
 Secure the accident scene
 Clear the way
 Follow up instructions
- 3. Further measures**
 Mark the emergency services
 Remove obstacles

Legend

- Blue dot: Current position
- Red square: Fire alarm call point
- Red square with extinguisher: Fire extinguisher
- Red square with equipment: Collection of firefighting equipment
- Red square with hose: Fire hose reel
- Green square with exit: Emergency exit
- Green square with arrow: Escape route
- Green square with cross: First aid
- Green square with person: Doctor
- Green square with group: Evacuation assembly point

Floor:	D-W:
Draftsman:	Date:
Logo Customer / Object	

Escape plans

A property's escape and rescue plans are designed for quick orientation so that the fastest and safest path out of danger can be identified. The plans complete the safety identification and increase the level of safety for people in the building. Consulting our on-site audit, we draw up the plans which present a simple, comprehensible of the escape routes and safety signs, fire extinguishers, wall hydrants, pressure detectors, first aid kits, stretchers etc. . They also contain the rules of conduct in accordance with Part A of the German Brandschutzordnung ("Fire safety regulation"), i.e. how to behave in the event of fire or accidents.

Installation plans

Within the framework of the on-site audit, we can conduct a variance analysis for the existing labelling or prepare a new documentation of the safety signage if you please. Our expert staff will record all of the signs that are present on your site and note all of the labels that are missing or need to be adapted. We will then create plans for you that include the positioning and fastening of the signs as well as the proper installation options. These plans can be used for an on-site installation by us or your own employees, for documenting your plant, or for further planning of your safety identification.

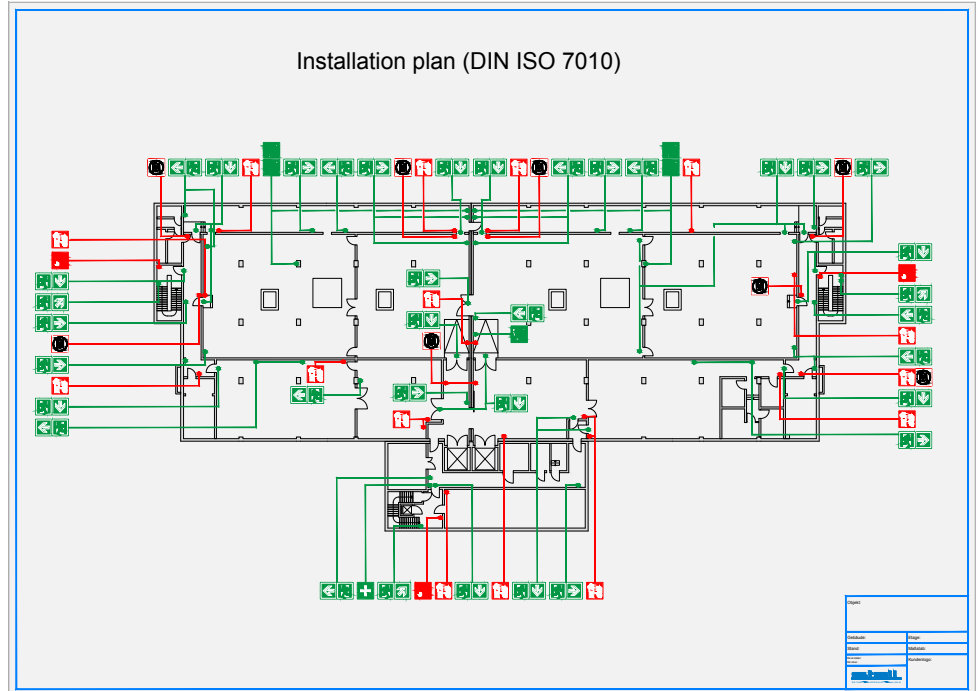

Fire safety regulation

The fire safety regulation includes the most important measures to follow for preventing and dealing with fires and is divided in the three following parts. Part A of the fire safety regulation addresses all persons in the relevant building and describes the most important rules in cases of fire or accidents. Part B addresses the employees of the company and, amongst others, describes general measures in order to prevent spread of fire and smoke and guidelines of how to keep clear the escape and rescue routes. The third Part C addresses employees of the company being in charge with fire prevention tasks and mainly describes fire protection measures. The fire safety regulation needs to be individually applied to every building and be checked every other 2 years by a fire prevention expert. Upon request, we can provide you with Part A as individual printouts; these can be complemented with Parts B and C as hardback copy.

Preventing fires

No naked flames; fire_unshielded ignition sources and smoking prohibited

Behaviour in the event of a fire

Keep calm

Report the fire

- Actuate the manual fire alarm
- Emergency number (0)112

Get to safety

- Warn persons at risk / actuate the fire alarm
- Assist others in need of help
- Close doors
- Follow the destined emergency exits
- Do not use the lift
- Go to the assembly point
- Follow instructions

Attempt to extinguish the fire

- Use the fire extinguisher
- Use the fire hose
- Use means and devices for fire-fighting (e. g. fire blanket)

Fire safety regulations in accordance with DIN 14096 / Object: _____ Creation Date: _____

Designs

Upon completion of our work, we give you a data medium that contains the digital documentation in the desired file format (supported file formats: *.PDF, *.DWG, *.DXF). You of course also have the option to use the printing and plotter service. This includes, amongst others, multi-colour printing, formats from DIN A4–DIN A0 and special formats upon

request, photoluminescent plots (e.g. for escape and rescue plans), and lamination up to DIN A 1. We offer a selection of folding frames in different shapes and sizes. If you are looking for a more appealing variant we recommend the acrylic frames of our own production.

Fastening and Accessories

In order for a sign to aid in providing comprehension, safety and orientation, it must be properly installed. Our fastening products therefore offer the right solution for each of our safety identification systems. Tried, tested and durable, the different sizes and types of signs can be fastened to the necessary installation points in a clearly visible manner. For further questions regarding our products our sales team is always at your disposal.

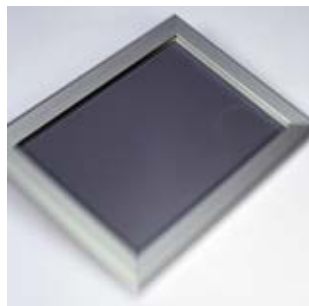

Snap frame

Material		Quantity	Article		
Aluminium, anodised		1 piece	0060		
Width x Height x Depth	Media size	mitred corner	rounded corner	lockable	fire protection certified
274 x 361 x 32 mm	DIN A4	Order-No. 2731 Price € 28,10	Order-No. 2732 € 30,60	–	47509 € 53,10
361 x 484 x 32 mm	DIN A3	Order-No. 2734 Price € 32,70	Order-No. 2735 € 35,70	2736 € 44,40	47508 € 63,30
484 x 658 x 32 mm	DIN A2	Order-No. 2737 Price € 47,00	Order-No. 2738 € 51,00	2739 € 58,70	47507 € 93,90

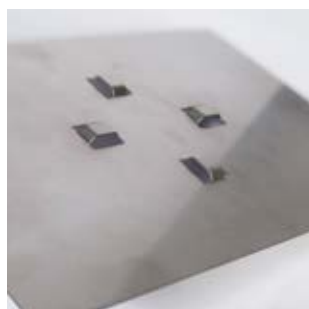

Sign mount

Material		Quantity	Article
Aluminium A / Stainless steel S		1 piece	0107
Width x Height	Lieferumfang	Mat.	Mat.
145 x 145 mm	incl. double faced adhesive foa tape	Order-No. 49542 Price € 6,50	36632 € 6,90
195 x 295 mm	mincl. double faced adhesive foam tape	Order-No. 49543 Price € 13,40	36633 € 14,40



Flag fastener

Material		Quantity	Article
Aluminium		1 piece	0061
Width x Height	Application	Order-No.	Price
150 x 150 mm	wall and ceiling suspension	2715	€ 7,20
150 x 300 mm	wall and ceiling suspension	Order-No. 2716 Price	€ 10,70
150 x 450 mm	wall and ceiling suspension	Order-No. 2717 Price	€ 11,40
200 x 200 mm	wall and ceiling suspension	Order-No. 2718 Price	€ 8,10
200 x 400 mm	wall and ceiling suspension	Order-No. 2719 Price	€ 13,80
200 x 600 mm	wall and ceiling suspension	Order-No. 2720 Price	€ 18,30
300 x 150 mm	wall suspension	Order-No. 2721 Price	€ 9,70
400 x 200 mm	wall suspension	Order-No. 2722 Price	€ 12,60



Nose fastener

Material	Quantity	Article
Aluminium	1 piece	0062
<i>Width x Height</i>		
150 x 150 mm	Order-No. Price	2701 € 10,30
150 x 300 mm	Order-No. Price	2702 € 12,10
200 x 200 mm	Order-No. Price	2704 € 11,70
200 x 400 mm	Order-No. Price	2705 € 15,00
200 x 600 mm	Order-No. Price	2706 € 18,20
300 x 300 mm	Order-No. Price	2703 € 15,80
400 x 400 mm	Order-No. Price	2707 € 21,50



Double-faced acrylate adhesive tape

Material	Quantity	Article
Acryl	1 piece	0063
<i>Width x Length</i>		
150 mm x 50 m	Order-No. Price	2699 € 168,50
200 mm x 50 m	Order-No. Price	2700 € 224,70



Double faced adhesive foam tape

Material	Quantity	Article
Polyethylenschaum	1 piece	0021
<i>Width</i>	<i>Application</i>	<i>Length 50 m</i>
150 mm	For signs	Order-No. Price 94 € 215,50
200 mm	For signs	Order-No. Price 95 € 288,40
300 mm	For signs	Order-No. Price 96 € 431,00
400 mm	For signs	Order-No. Price 97 € 571,90



Cartridge skeleton gun

Quantity	Article
1 piece	0091
<i>Application</i>	Order-No. Price 5456 € 13,00



Glue

	Quantity	Article
	1 piece	0091

<i>Design</i>	<i>Application</i>	Order-No.	47477
Cartridge, 310 ml	For the assembly of signs, transparent	Price	€ 17,30



Cleaner sprays

	Quantity	Article
	1 piece	0091

<i>Design</i>	<i>Application</i>	Order-No.	33847
Spray can, 500 ml	For degreasing metallic surfaces, glass and ceramics (check suitability before use)	Price	€ 12,50
Spray can, 500 ml	For cleaning heavily soiled surfaces	Order-No.	33848
		Price	€ 7,10

Terms and Conditions

1. General

1.1 The following "Terms and Conditions – Purchase Contract", in here later referred to as "terms and conditions", apply to all purchase contracts between the Stell GmbH (Limited liability company), Raiffeisenring 35-37, 46395 Bocholt, Deutschland (in here later referred to as "seller") and enterprises according to § 14 BGB, legal bodies under public law and legal assets under public law (in here later referred to as "buyer").

1.2 Contradicting or differing terms and conditions of the buyer are no subject to the contract even if the seller is fulfilling the contract without having explicitly refused those terms. Differing terms only apply if explicitly agreed to by the seller in writing.

2. Contract proposal and conclusion, offers, orders

2.1 The offers of the seller are non-binding and shall be considered as a proposal towards the buyer to place a purchase order with the seller. The purchase contract (in here later referred to as "order") is concluded with the placement of the order by the buyer and the acceptance of the order by the seller. If the acceptance notice differs from the order, it is to be considered a new, non-binding offer of the seller.

2.2 By placing the order the buyer bindingly declares to willingly purchase the ordered products. The seller is entitled to accept the offer for the order within 2 weeks after the placement of the order. By placing the order, the buyer agrees to the present terms and conditions. The same applies to all future purchase orders even if the terms and conditions are not explicitly referred to.

2.3 The buyer is obligated to immediately revise the acceptance notice/order confirmation of the seller. If no formal acceptance notice has been issued, the former applies also to instalments, partial or final accounts.

2.4 The granting of a certain property or suitability of the ordered product concerning a certain intended use as well as taking over a guarantee is only binding if confirmed by the seller in writing. The properties of patterns or samples are only binding as long as explicitly agreed to be properties of the product.

2.5 As far as the seller provides advice and support services, those are provided to the best of his/her knowledge.

3. Purchase price, payment, default, off-set, retention, transfer of claims

3.1 (a) All prices are ex office of the seller.

(b) Generally, the purchase price is excluding present statutory VAT as far as legal tax obligations apply. If the statutory VAT rate increases between the conclusion of the contract and the issuance of the invoice, the buyer has to pay the higher VAT rate.

(c) On deliveries within the EU, the buyer has to provide his/her VAT ID number used for his/her turnover taxation prior to the payment. For non-electronic export declarations concerning deliveries from the Federal Republic of Germany to countries outside of the EU which are not carried out or initiated by the seller, the buyer has to provide the export declaration necessary for taxation. If the export declaration is not provided, the buyer has to pay the VAT for the products in addition to the invoiced amount for deliveries within Germany.

(d) The seller is entitled to claim down payments according to the value of already performed partial deliveries.

3.2 If the agreed delivery term exceeds 4 months, the seller reserves the right to reasonably adapt the agreed purchase price according to changes of actual costs, including material costs and labor expenses as well as shipping costs if necessary. The same applies in case of increase of customs or fees required for deliveries at the seller's expense. If the price not proportionally increases compared to the consumer price index, the price increase will be limited to the market price. Paragraph 4.12 remains untouched.

3.3 The agreed purchase price is due within 7 days after the delivery of the product to the buyer without deductions, unless otherwise agreed upon. The same applies to partial deliveries. Trade discounts may only be deducted if the payment has been credited to the seller's account in due time and if the buyer is not in default with other claims of the seller at the time of the respective payment. Trade discounts may only be deducted from the net price.

3.4 Drafts and checks will only be accepted on account of performance and upon explicit agreement. They will not be considered as payment until they are encashed. Draft charges and taxes are at the buyer's expense after the expiry of the agreed payment term.

3.5 The buyer defaults in payment after the expiry of the 7th day after the delivery of the product, latest after expiry of the last day of an individually granted payment period.

3.6 (a) The buyer may only off-set against claims of the seller with undisputed, final and absolute counter claims.

(b) Letter (a) respectively applies to the execution of retention rights by the buyer.

3.7 The buyer is not entitled to retain claims of the seller resulting from this contract due to unsettled claims not subject to this contract. **3.8** The buyer's right to lien according to § 369 HGB does not apply.

3.9 If there are reasonable doubts concerning the liquidity or credit status of the buyer and if the buyer is not willing to pay in advance or provide a suitable financial security on demand of the seller, the seller is entitled, if he/she has not performed yet, to demand an advanced cash payment before a

possible further/subsequent delivery. This particularly applies to agreed, but not yet carried-out subsequent business transactions.

3.10 The seller reserves the right to use payments to settle the oldest open account item plus incurred default interests according to the following order: costs, interests, principle claim.

3.11 The seller is entitled to transfer claims resulting from or in relation to this purchase contract. The buyer may not transfer his claim against the seller to third parties. § 354a HGB remains unchallenged.

3.12 On default of payment of remuneration claims, the seller is entitled to claim default interest of 8 %-points above the basic interest rate according to § 247 BGB valid at the time of default occurrence. § 352 HGB as well as claims towards further actual default damages remain unchallenged, so do legal rights to claim damages for the failure of performance as well as withdrawal from the contract.

3.13 On default, all claims resulting from all contract relationships of the parties are due immediately, unless the default is related to only minor claims.

4. Delivery, transfer of risk

4.1 If no explicit delivery term has been stated by the seller, the delivery may be claimed not until 8 weeks after the conclusion of the contract. An agreed approximate delivery term does not begin until receipt of all necessary documentations and information to be handed in by the buyer (P&IDs, specifications, production lists, approval of layouts).

4.2 If the buyer has been granted a certain delivery period, this period is to be considered as complied with if the product to be delivered has been delivered to the customer. If the purchase contract consists of several partial deliveries, the acceptance has to take place according to the agreed delivery intervals.

4.3 If not otherwise agreed upon, the products are provided for delivery at the seller's place of business. On collection from the delivery point the collection has to take place by the buyer or his/her representatives according to legal regulations concerning secure loading of vehicles.

4.4 If a dispatch of products has been agreed upon, the seller dispatches the products on request of the buyer according to § 447 BGB at the buyer's risk and expense.

4.5 If employees of the seller support the loading of vehicles according to paragraphs 4.3, 4.4 outside the scope of agreed services on request of the buyer, they solely act on behalf of the buyer.

4.6 (a) The risk transfers latest on handing over the product to the forwarding/collecting agent according to paragraph 4.3, also in the event of partial deliveries or if the seller has taken over additional services, such as dispatch

or direct delivery of the products. On request of the buyer, the shipment will be insured against theft, physical, fire or water damages and other insurable risks by the seller acting as a mediator only.

(b) If the buyer defaults in acceptance, the seller is entitled to store the products without further notice/reminders at the buyer's expense and risk.

(c) If the buyer defaults in acceptance, the purchase price is due immediately.

4.7 Partial deliveries by the seller are accepted, if reasonable to the buyer under consideration of the interest of both parties.

4.8 The acceptance of the shipment without objections by the forwarding/collecting agent is to be considered proof of intact packaging and correct loading, unless the buyer proves that the packaging was damaged or the loading did not take place correctly on handing over the shipment to the forwarding/collecting agent. Complaints due to transport damages are to be reported immediately to the company in charge of the shipment with a copy to the seller.

4.9 If the parties use INCOTERMS clauses for an individual purchase contract, those terms apply in the version valid at the time of concluding the contract. Possible contradictions with other terms of paragraph 4 of this agreement are overruled by the agreed INCOTERMS regulations.

4.10 The buyer is responsible for the compliance with legal and official regulations concerning import, delivery, storage and use of the services and deliveries performed by the seller in the country or place of destination as well as in the transit countries as well as responsible for the acquisition of required import and transit documents (custom etc.) as long as those are not exclusively to be provided by the seller due to legal reasons.

4.11 All deliveries are subject to correct and due supply of the seller.

4.12 If it has been exceptionally agreed upon that the seller is to bear custom or export/import costs of the country of origin/destination or of transit countries, the cost increase occurring in between the time of the acceptance of order and delivery of the contractual products transfers to the buyer.

5. Reservation of title

5.1 Products remain property of the seller until complete payment of all receivables resulting from the business relationship with the buyer are settled.

5.2 The reservation of title also persists if single claims of the seller are added to a running account and the account is balanced and confirmed.

5.3 The return of reserved products does only represent a withdrawal from the contract, if explicitly declared by the seller in writing. If the seller withdraws from the contract, he/she may claim a reasonable compensation for

the duration the products were in possession of and in use by the buyer.

5.4 (a) The buyer is entitled to use the products owned by the seller in the usual course of business as long as he/she complies with his/her duties resulting from the business relationship with the seller. Not included in the usual course of business is the transfer of claims concerning the purchase price from the buyer to his customer(s); in particular: pawning, mortgage or other encumbrances of the products are prohibited.

(b) All claims of the buyer resulting from the resale of products owned by the seller are already by now transferred to the seller for security reasons, if applicable in the amount of the co-ownership share. Confirmed receivables resulting from current account agreements the buyer already transfer to the seller at the time of concluding the contract with the seller in the amount of accounts receivable. If the buyer defaults in payment, the seller is entitled to claim the interim return of the products owned by the seller even without withdrawing from the contract and setting an additional grace period at the buyer's expense.

(c) In the event of processing of products owned by the seller, the seller is to be considered the manufacturer and gains a co-ownership proportionally to the invoiced value of his own products.

(d) If the product of the buyer is to be considered the final product in the event of attaching or blending of products owned by the seller with goods of the buyer, the co-ownership of the product transfers to the seller in the amount of the invoiced value of his/her own product or the current market value of the final product, if an invoiced value is not existent. In these cases the buyer is to be considered the custodian of the product.

5.5 In the event of resale of products owned by the seller, the buyer is obligated to arrange regulations concerning the reservation of title with his customers without revealing the original reservation of title agreed upon with the seller. (Secondary reservation of title)

5.6 If the seller has reasonable concerns that the buyer is not fulfilling or will not fulfil his/her duties towards the seller, the buyer is to order his/her customers on demand of the seller to abstain from demands to receiving information about the stock of seller-owned products and receivables transferred to the seller as well as to being handed out documents to enforce transferred receivables. The same applies in case of withdrawal of the direct debit authorization. Access to reserved products by third parties and transferred receivables is to be announced immediately.

5.7 If the security value exceeds the claims of the seller by more than 10 %, the seller will release securities on the buyer's request.

6. Warranty, Guarantee

6.1 If not individually agreed upon, the seller delivers the product according to the terms stated in the regular product description (catalogues etc.), otherwise according to standard quality. Ad-

ditional properties of the product to be purchased stated in other publications or advertisements of the seller or his/her suppliers/manufacturers may not be derived by the buyer unless the seller has confirmed those additional properties in writing. Guarantees require an explicit written confirmation by the company management of the seller.

6.2 Subject to compliance with inspection and objection obligations of the buyer according to Section 377 German Commercial Code (HGB) in connection with paragraph 6.3 of this agreement, the seller may choose to compensate for defective products between rectification of the defect or new delivery. The seller reserves the right of two rectification attempts. The seller is entitled to reject the chosen rectification method if rectification would result in unproportionally high costs and the other method of rectification is possible without significant disadvantages for the buyer. If the rectification fails, the buyer is entitled either to claim a reduction of the purchase price or to withdraw from the contract. The right of the buyer to legally claim compensation for damages or necessary expenses according to the law, in addition to withdrawing from the contract, remains unchallenged, except the limitations for claims of the buyer according to paragraph 7 of this agreement.

6.3 The defect notice according to Section 377 German Commercial Code (HGB) may only be issued by the buyer in writing. Further legal requirements according to Section 377 German Commercial Code (HGB) remain unchallenged. Regardless of that, guarantee claims of the buyer are excluded if the buyer fails to report obvious defects in writing within one week from the date of delivery until dispatch of the written defect notice.

6.4 The delivery of defect-free product for the purpose of rectification generally takes place only in exchange to the return of the defective product.

7. Liability

In cases of contractual or non-contractual liability, the seller compensates for damages or lost expenses according to the following regulations:

7.1 The seller is liable to the full amount in cases of intent or gross negligence.

7.2 On lack of a property for whose existence the seller has taken over a guarantee or which has been assured to the buyer, the seller is liable for the typical, foreseeable damage which was supposed to be prevented through the guarantee or assurance as long as the lack of the guaranteed/assured property was caused by intent or gross negligence.

7.3 In case of light negligent violation of essential contractual obligations (cardinal obligations), the liability of the seller is limited to the compensation for the typical, foreseeable damage; in case of light violation of non-cardinal obligations, liability of the seller is excluded.

7.4 The above mentioned limitations of liability do not apply to claims of the buyer under the Product Liability Act

and resulting from harm to life, body and health caused by the seller.

7.5 Other legal obligations concerning compensation or exclusion of liability, such as Section 281, paragraph 1, sentence 3 German Civil Code (BGB) remain unchallenged.

8. Force Majeure

In case of events or circumstances, such as natural events, war, labor disputes, raw material and energy shortage, traffic and facilities disturbances, fire and explosion damages, orders of higher authorities whose occurrence are outside the sphere of influence of the seller, even under consideration of careful commercial planning and precaution, and which impair the availability of products from the source from which the seller is supplied so that the seller is not able to fulfil his/her contractual duties (under partial consideration of other internal and external delivery obligations), the seller is (i) relieved from his/her contractual duties for the duration and extend of the disturbance and (ii) is not obligated to obtain the products from third parties.

Sentence 1 also applies as long as the events and circumstances make the execution of the respective business sustainably uneconomic for the seller or influence the seller's suppliers. If those events last longer than 3 months the seller is entitled to withdraw from the contract.

9. Confidentiality, data protection

9.1 The parties agree to treat all confidential information and industrial secrets of the other party collected within the scope of execution of the contract confidentially without temporal limits and to use them only within the scope of executing the contract.

9.2 Both parties comply with data protection regulations. The handling of the business relationship will be supported by a data processing system of the seller, thus data of the buyer will be automatically collected and stored. The buyer will be informed about the storage of his/her data.

10. Industrial property rights

10.1 The buyer is responsible that property rights of third parties are not violated by the seller receiving and using materials of the buyer, such as documentations, data, drafts, planes or other execution instructions provided by the buyer necessary for the execution of the contract, and relieves the seller from all related claims. The buyer bears license fees or costs resulting from the avoidance of such violations of property rights.

10.2 If industrial property rights occur within the scope of the execution of contractual agreements, the buyer is to transfer those rights to the seller if legally possible. If the full transfer of rights is not possible, the buyer grants the seller an exclusive, over-all usage right, unlimited in time and space or, if even this is not possible, a non-exclusive right. Legal regulations which grant the buyer a reasonable compensation for the transfer of rights remain un-

challenged.

10.3 The buyer has no property rights towards films, plans, drawings and graphics compiled in the course of the preparation of purchase product. In particular, industrial property rights on those as well as on the contractual products remain with the seller. By full payment of the remuneration, the buyer gains the ownership on the delivered products.

10.4 The seller is entitled to perform or deliver products to third parties, comparable to the products delivered to or compiled for the buyer, in particular films, plans, drawings and graphics. The seller is entitled to attach an adequate copyright label or label of origin to all contractual products.

10.5 The seller is entitled to use the purchase of products delivered to the buyer within reason for own advertising and promotion purposes in any form, such as illustrations of products and the place of use at the buyer's facilities in brochures or electronic media. This right does only not apply if the buyer explicitly disagrees to such use by the time of his/her declaration of intent towards concluding the contract.

11. Place of execution, place of jurisdiction, choice of law, severability clause, written form

11.1 Place of payments by the buyer is the company residence of the seller.

11.2 (a) Place of jurisdiction for all claims resulting from or in relation to the respective purchase contract, concerning its conclusion, its effectiveness and execution is the usual place of jurisdiction of the seller or, on request of the seller, the usual place of jurisdiction of the buyer.

(b) If the buyer has his/her residence outside of the EU, all law suits resulting from or in relation to the respective purchase contract, concerning its conclusion, its effectiveness and execution are carried out according to the arbitration regulations of the German Institution for Arbitration (DIS) under exclusion of the legal recourse. Decisions are made by a single arbitrator who has to have a qualification to judgeship and is appointed according to Section 14 of the German DIS Arbitration Code. The place of arbitration is the place of residence of the seller. The language of arbitration is German. The gathering of evidence takes place under application of the valid regulations of the German Civil Code concerning the gathering of evidence.

11.3 German law is applied under exclusion of CISG law (United Nations Convention on Contracts for the International Sale of Goods) as well as the referral regulations of the German International Civil Law.

11.4 If single regulations of these terms of service are entirely or partially invalid or have legal gaps, the effectiveness of other regulations or parts of regulations remains unchallenged.

11.5 The German version of these terms of service is legally determinative. The publication of a version in another language takes only place for the purpose of easier comprehension.



stell

Stell GmbH
Raiffeisenring 35-37
46395 Bocholt
Germany
info@stell.de
stell.de